

Frame Floor: Step by Step

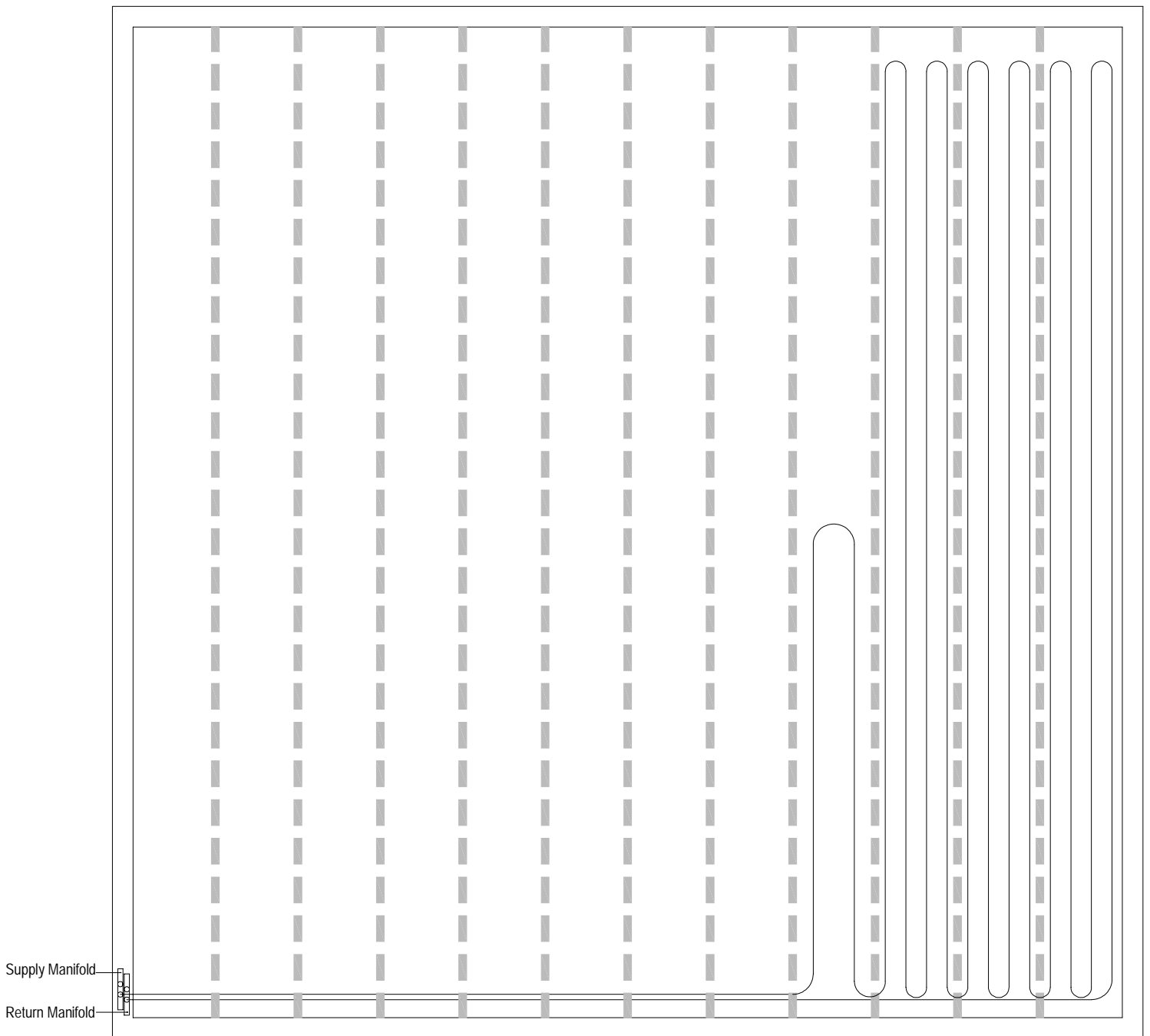

The above illustration shows a serpentine layout with a banded area running parallel to the exposed wall. The banded area is spaced at 4" oc.

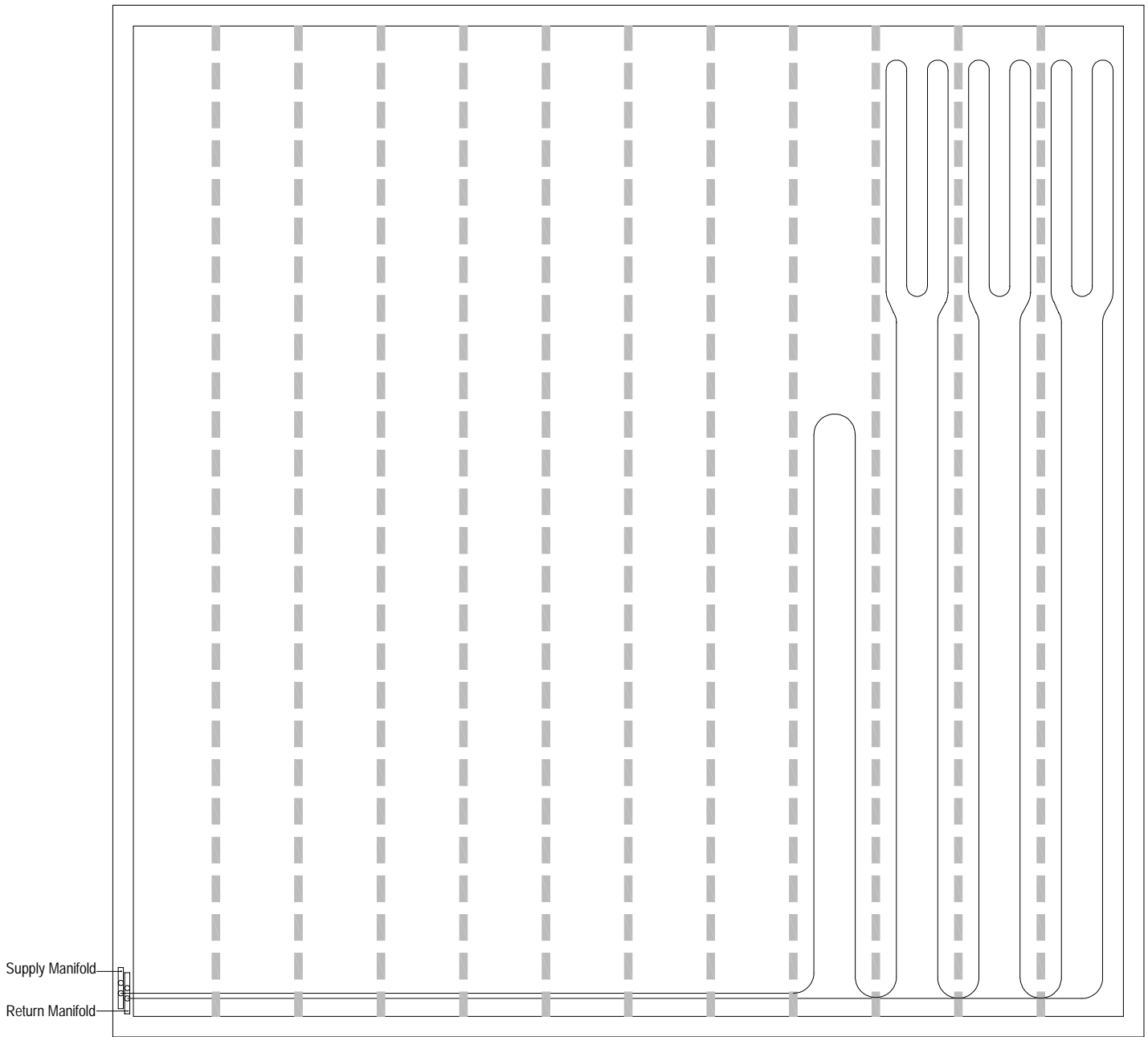

The above illustration shows a serpentine layout with a banded area running perpendicular to the exposed wall. The banded area is spaced at 4" oc.

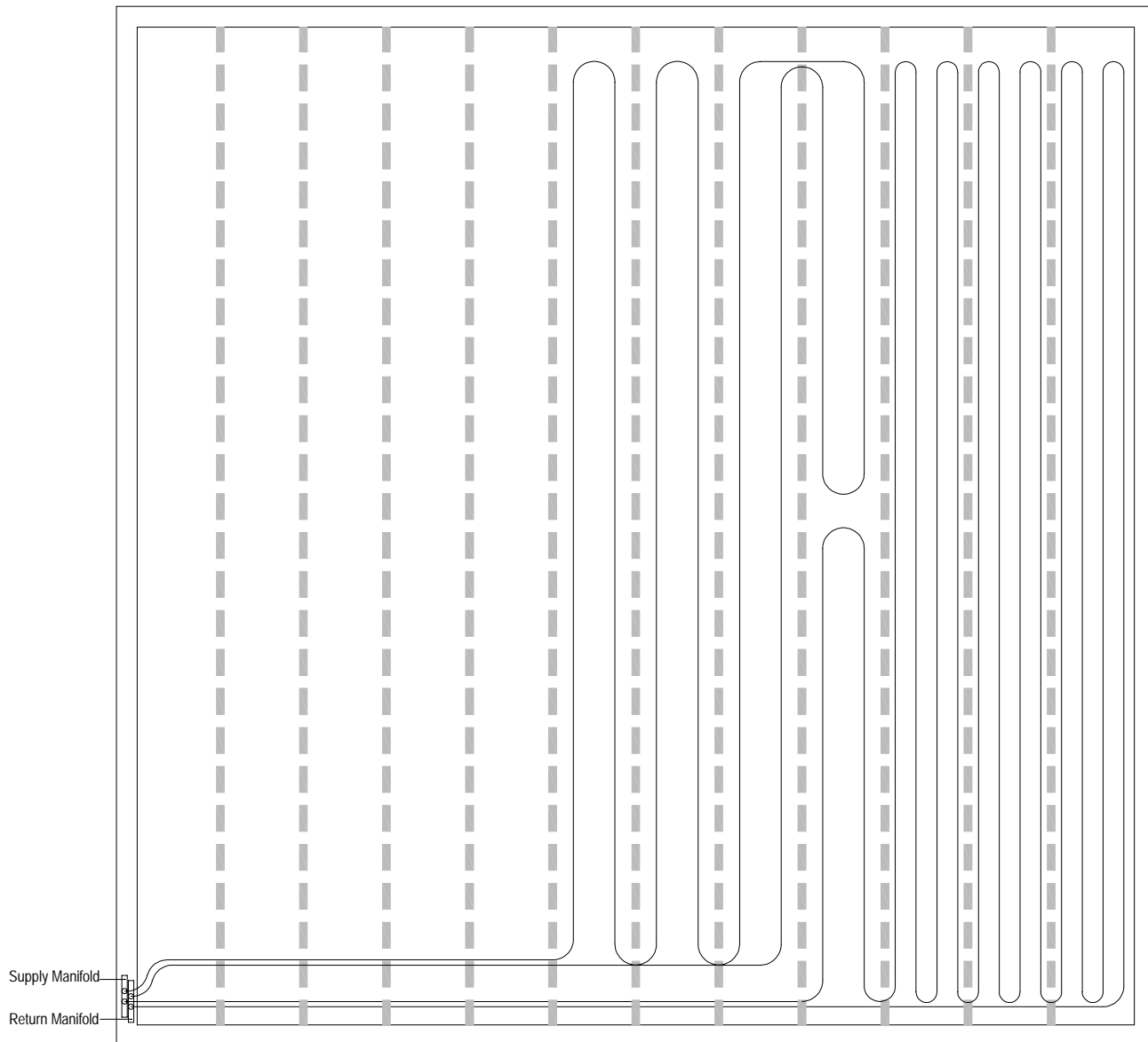

The above illustration shows how to "pick up" a bay when the previous circuit terminates mid-run. The second circuit loops back down the open bay from the far end. The remainder of the circuit is installed in the same fashion as the first circuit.

Frame Floor

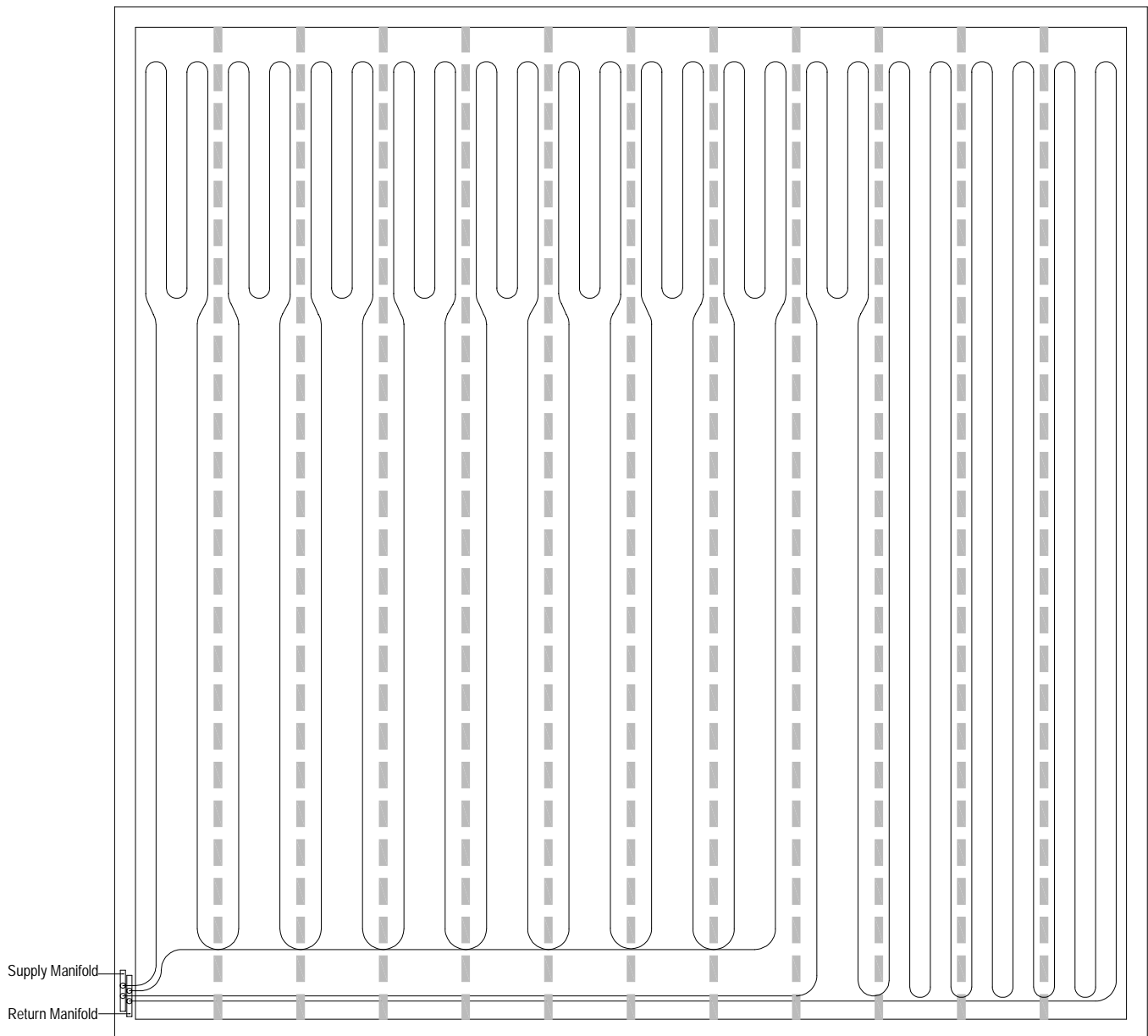

Single Serpentine Layout with Banding: Banding is used along exposed walls or areas of excessive heat loss. Banding allows for more tubing to be installed in a given area, which increases the floors heating output. This higher output helps off-set the heat loss. Banded spacing is usually 4 ft. in from the exposed wall and is usually half the spacing as the main room.

Frame Floor: Counter Flow Method

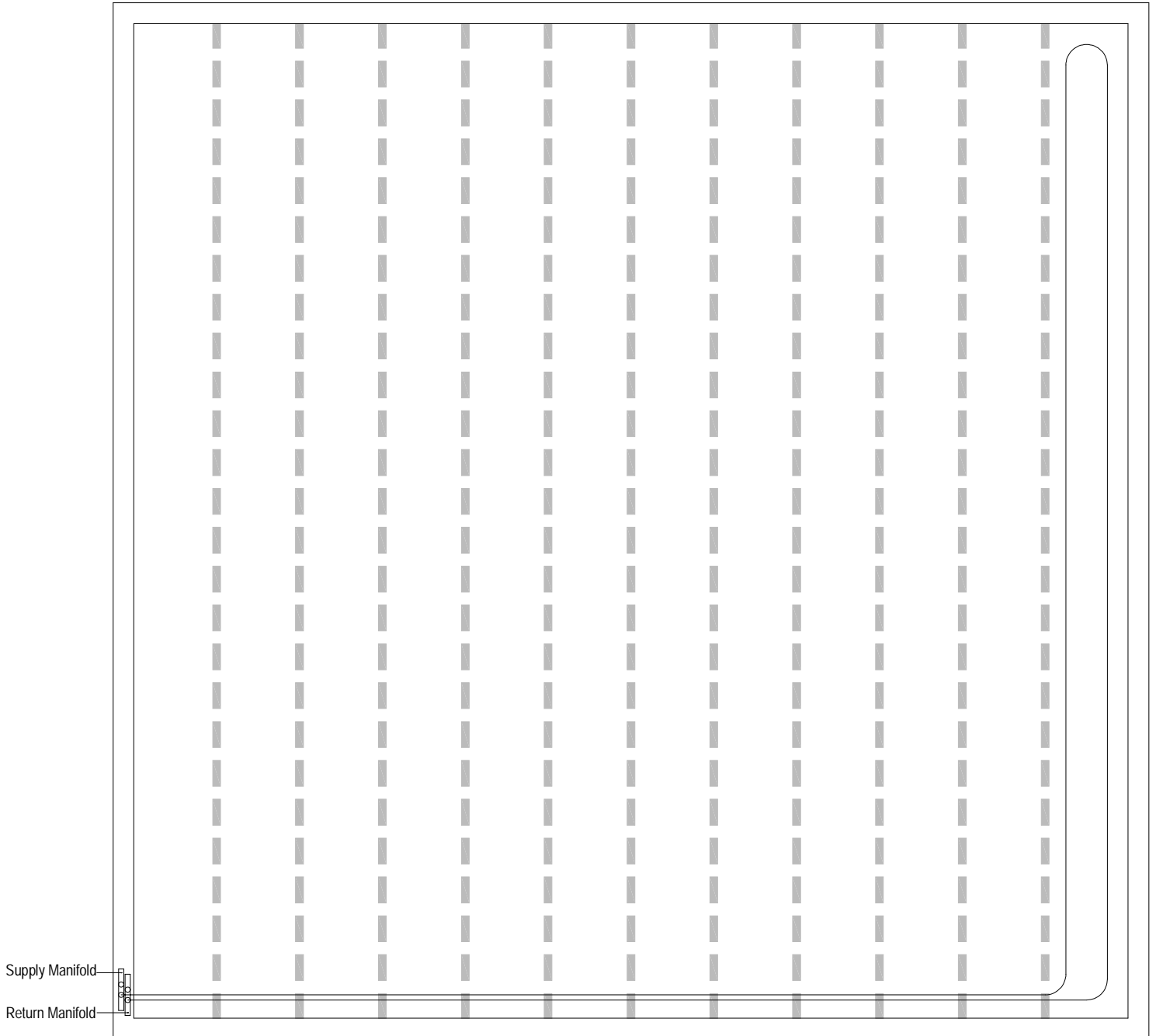

Step 1

Frame Floor: Counter Flow Method

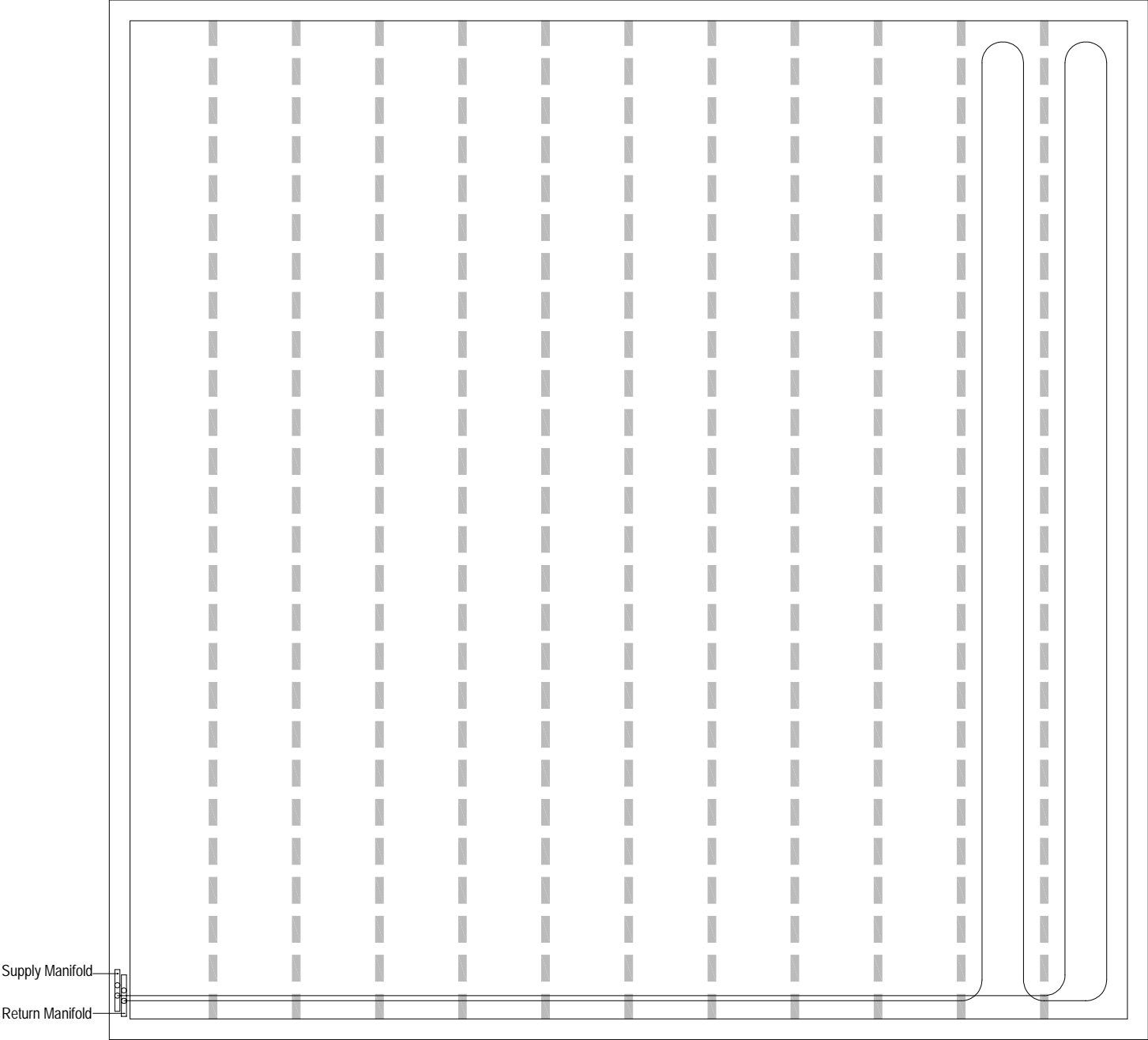

Step 2:

Frame Floor: Counter Flow Method

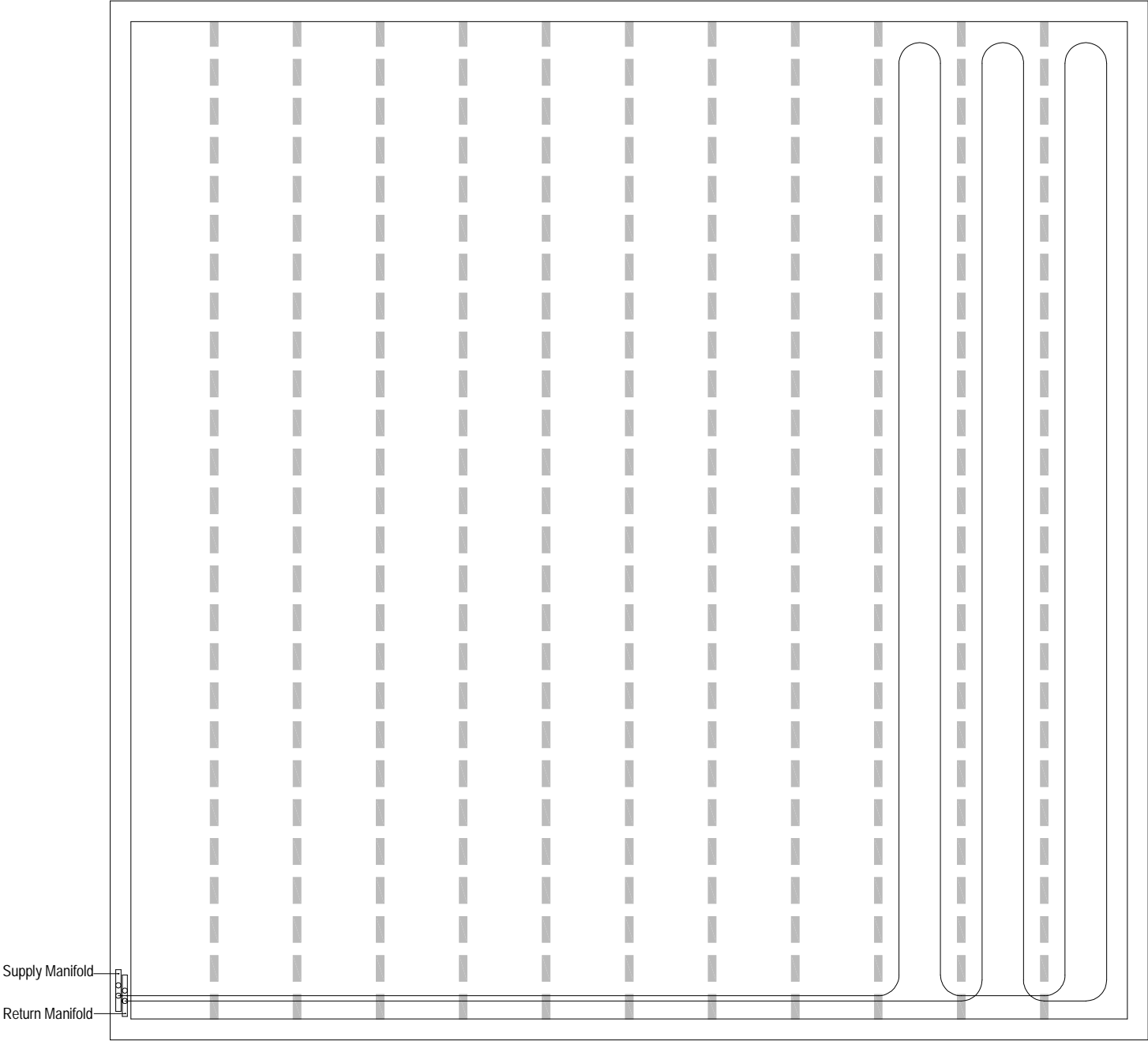

Step 3:

Frame Floor: Counter Flow Method

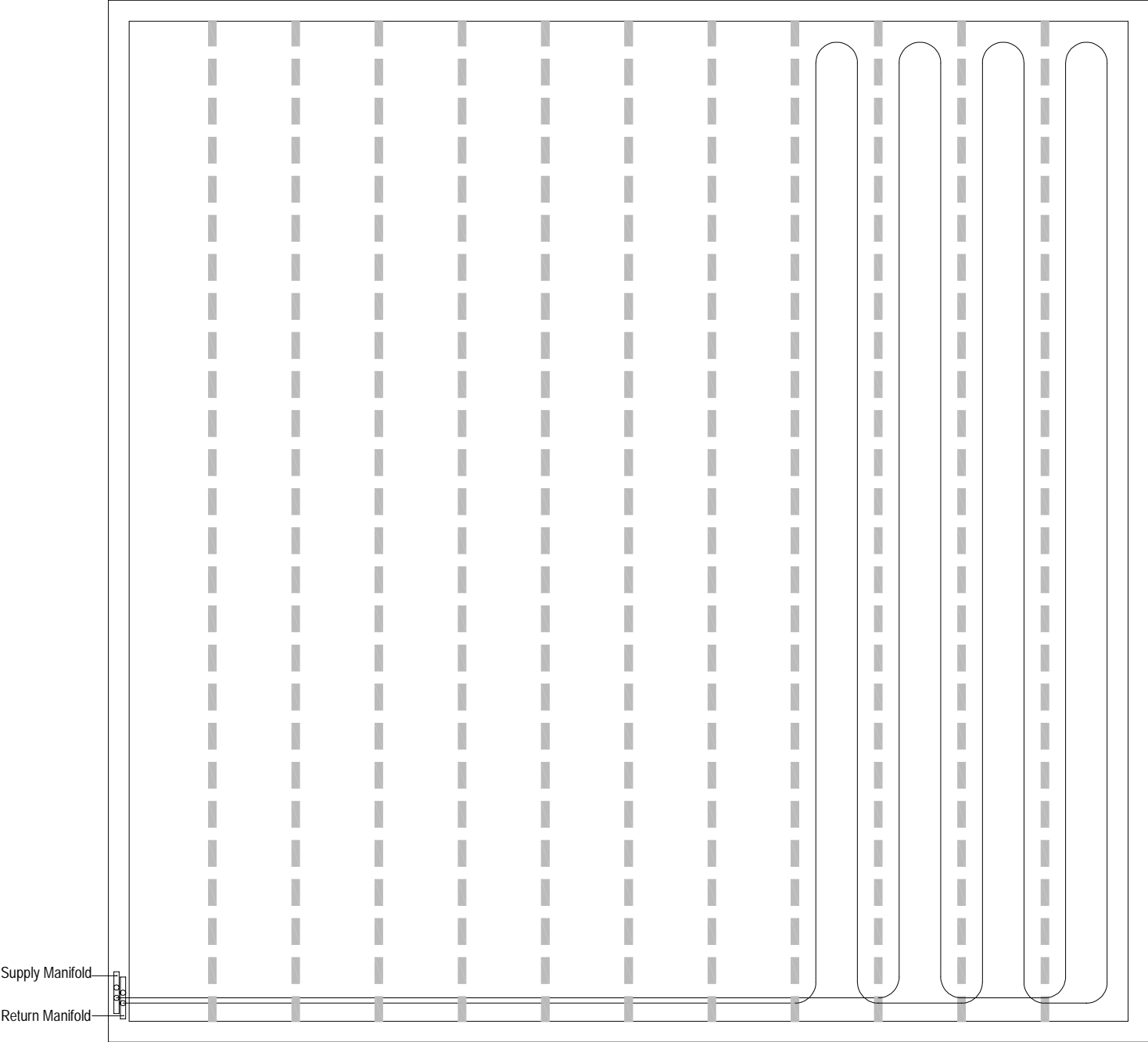

Step 4:

Frame Floor: Long Manifold

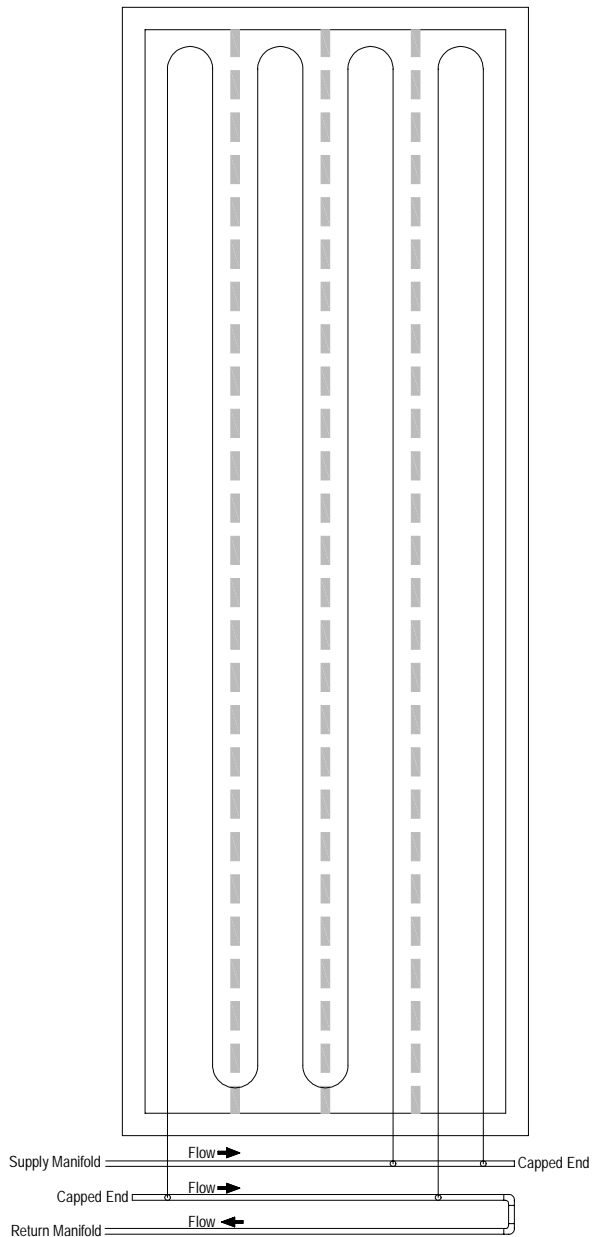

Long manifolds are installed perpendicular to the floor joists. To ensure balanced flow through each circuit, a reverse return method is recommended. A reverse return manifold requires a third copper line to be ran. This extra line allows each circuit to "see" the same total manifold length, thus creating a balanced system.

STAPLE-UP APPLICATION

Watts Radiant

Radiant Floors & Snowmelting

Ph: 417/864.6108

Fax: 417/864.8161







GENERAL NOTES:

Cross sections are intended to illustrate typical radiant installations. Floor construction details shown are to be used for illustrative purposes only, not for actual construction. Structural details will need to be determined by the project engineer, architect or other.

SPECIFIER INFORMATION:

ONIX CROSS SECTIONAL DETAILS:

General Legend

-  Concrete (Thin Slab)/ Mud
-  Joist/Sleepers
-  Plywood
-  Sand Fill
-  Board/Batt Insulation
-  Gravel Bed/ Earth Fill

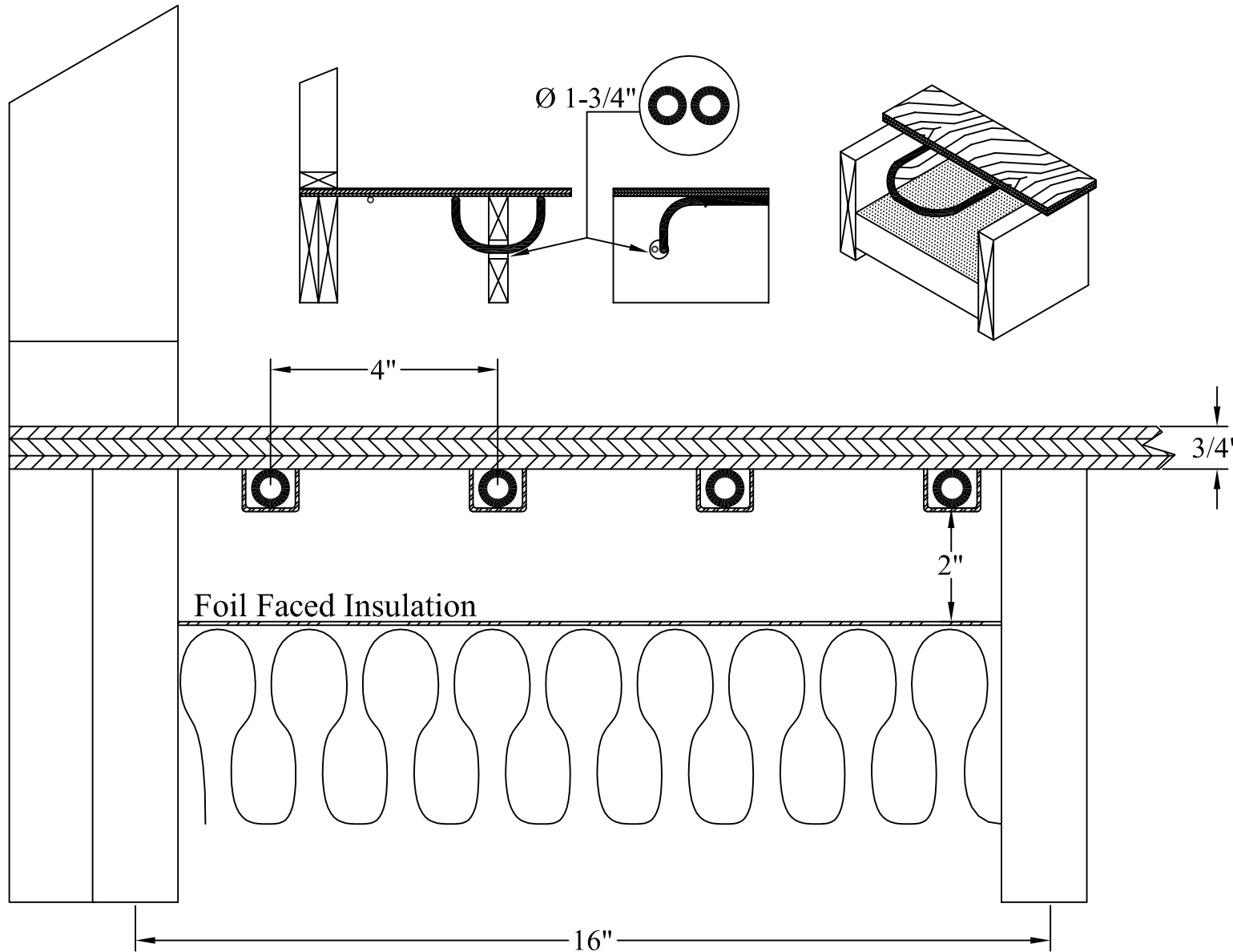

STAPLE-UP APPLICATION

Watts Radiant

Radiant Floors & Snowmelting

Ph: 417/864.6108

Fax: 417/864.8161







GENERAL NOTES:

Cross sections are intended to illustrate typical radiant installations. Floor construction details shown are to be used for illustrative purposes only, not for actual construction. Structural details will need to be determined by the project engineer, architect or other.

SPECIFIER INFORMATION:

ONIX CROSS SECTIONAL DETAILS:

General Legend

-  Concrete (Thin Slab)/ Mud
-  Joist/Sleepers
-  Plywood
-  Sand Fill
-  Board/Batt Insulation
-  Gravel Bed/Earth Fill

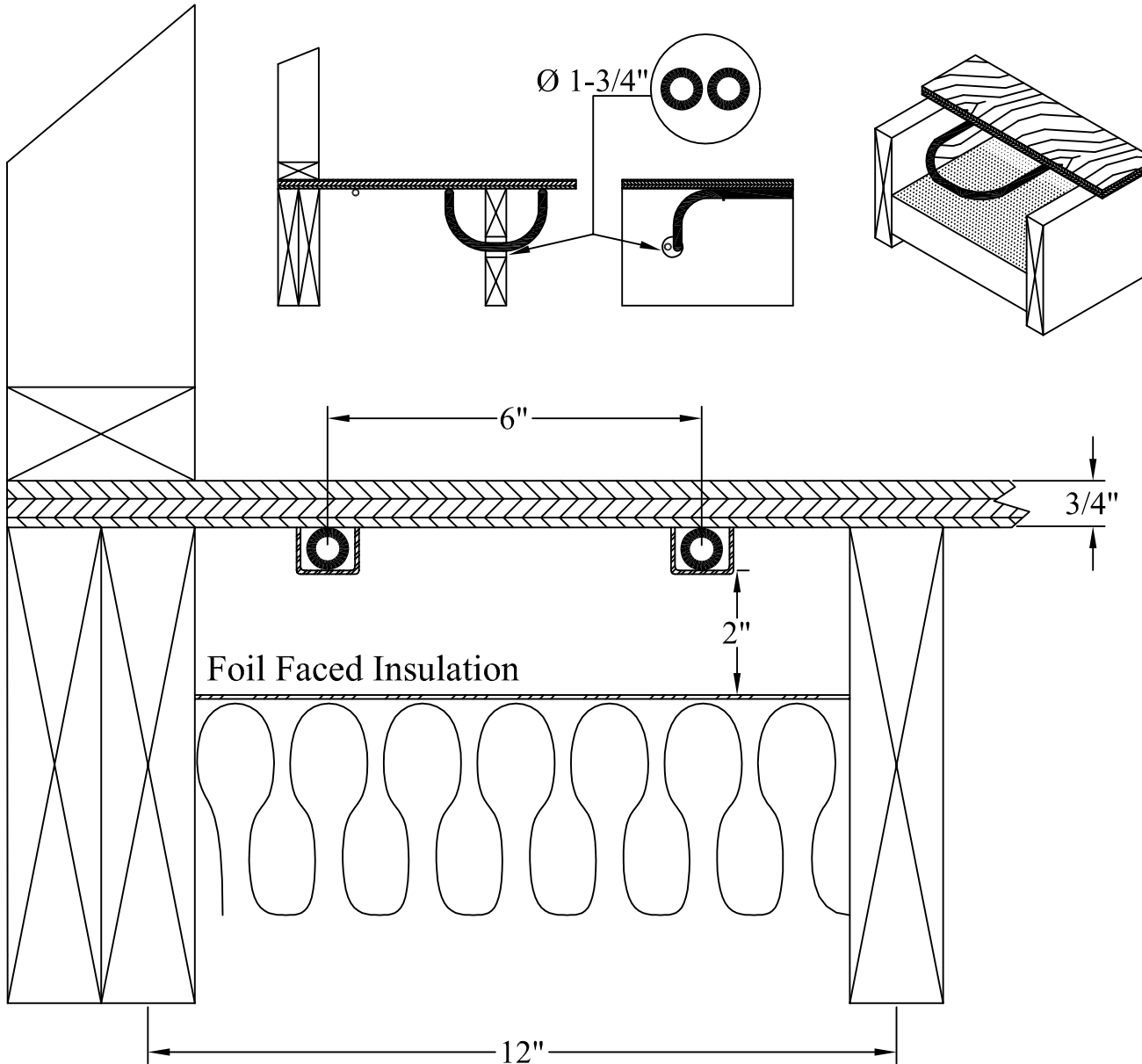

STAPLE-UP APPLICATION

Watts Radiant

Radiant Floors & Snowmelting

Ph: 417/864.6108

Fax: 417/864.8161







GENERAL NOTES:

Cross sections are intended to illustrate typical radiant installations. Floor construction details shown are to be used for illustrative purposes only, not for actual construction. Structural details will need to be determined by the project engineer, architect or other.

SPECIFIER INFORMATION:

ONIX CROSS SECTIONAL DETAILS:

General Legend

-  Concrete (Thin Slab)/ Mud
-  Joist/Sleepers
-  Plywood
-  Sand Fill
-  Board/Batt Insulation
-  Gravel Bed/Earth Fill

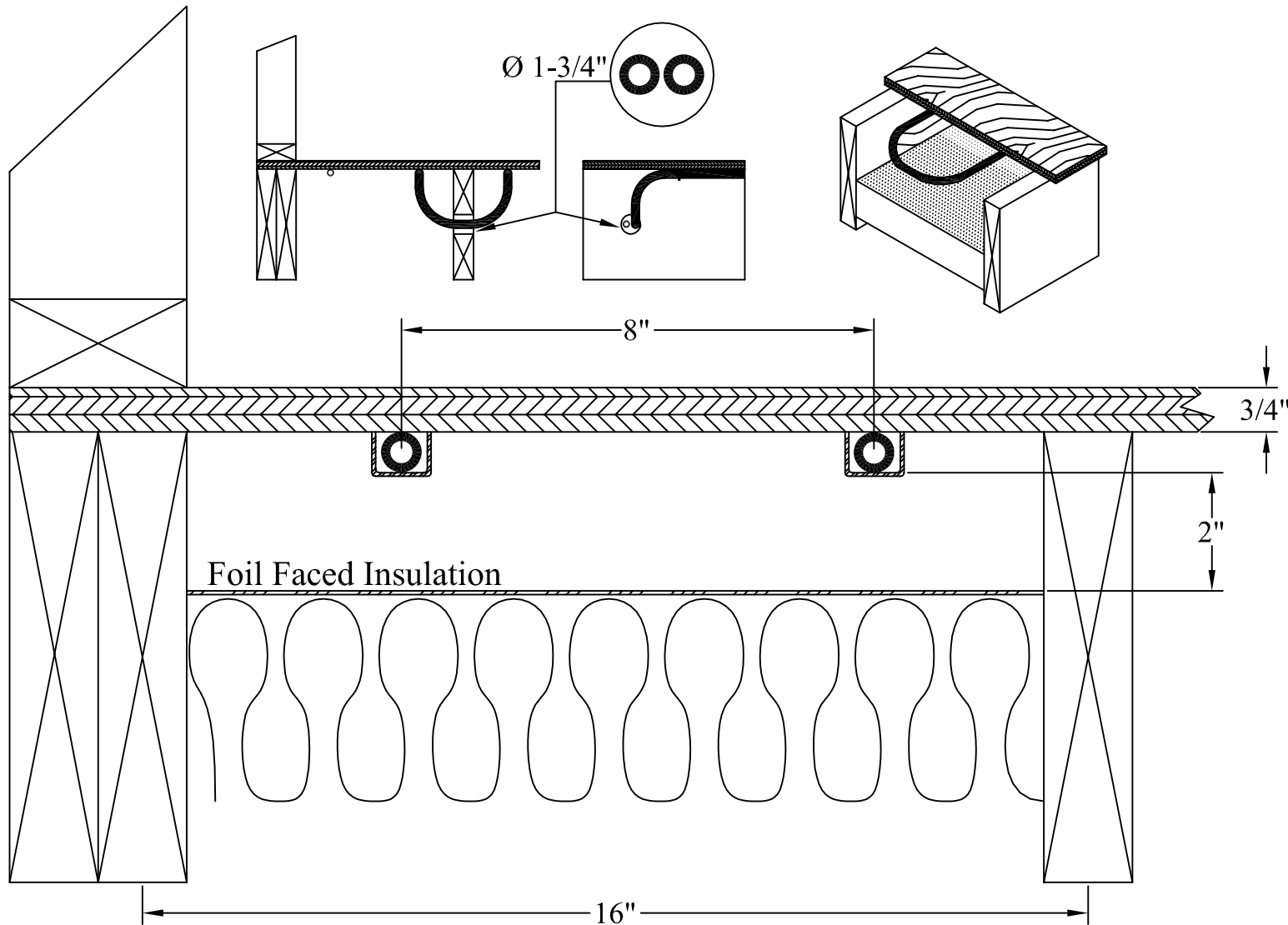

STAPLE-UP APPLICATION

Watts Radiant

Radiant Floors & Snowmelting

Ph: 417/864.6108

Fax: 417/864.8161







GENERAL NOTES:

Cross sections are intended to illustrate typical radiant installations. Floor construction details shown are to be used for illustrative purposes only, not for actual construction. Structural details will need to be determined by the project engineer, architect or other.

SPECIFIER INFORMATION:

ONIX CROSS SECTIONAL DETAILS:

General Legend

-  Concrete (Thin Slab)/ Mud
-  Joist/Sleepers
-  Plywood
-  Sand Fill
-  Board/Batt Insulation
-  Gravel Bed/Earth Fill

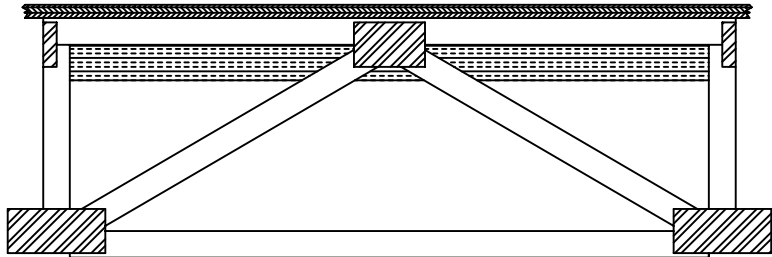
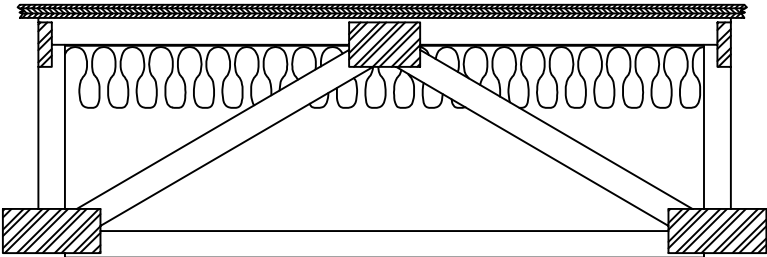
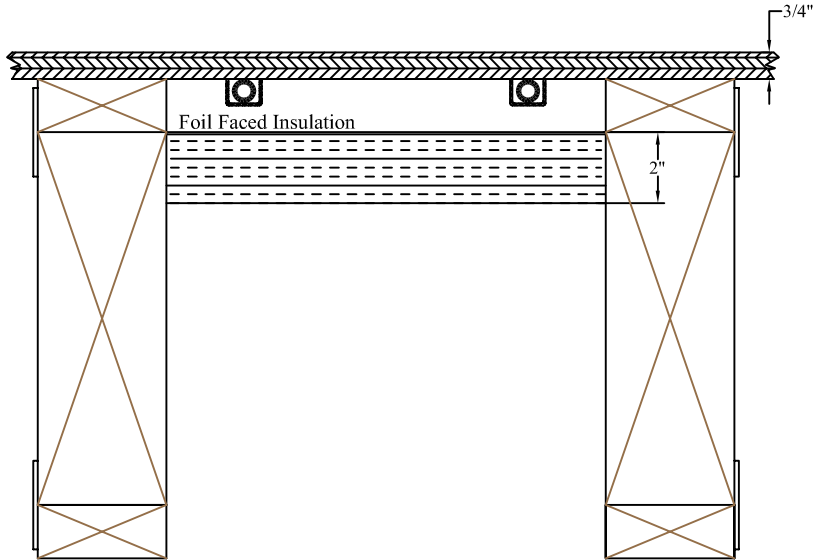
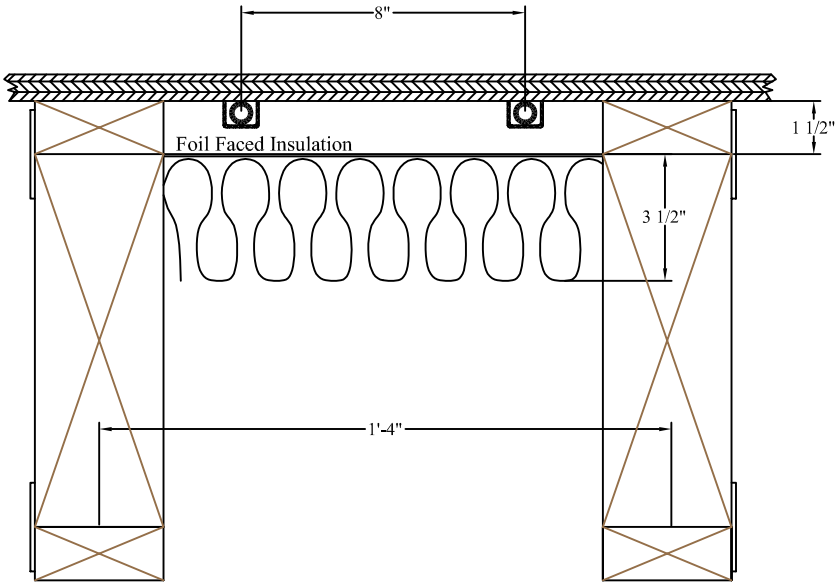

STAPLE-UP APPLICATION

Watts Radiant

Radiant Floors & Snowmelting

Ph: 417/864.6108

Fax: 417/864.8161







GENERAL NOTES:

Cross sections are intended to illustrate typical radiant installations. Floor construction details shown are to be used for illustrative purposes only, not for actual construction. Structural details will need to be determined by the project engineer, architect or other.

SPECIFIER INFORMATION:

ONIX CROSS SECTIONAL DETAILS:

General Legend

-  Concrete (Thin Slab)/ Mud
-  Joist/Sleepers
-  Plywood
-  Sand Fill
-  Board/Batt Insulation
-  Gravel Bed/Earth Fill

