

SLAB SNOWMELT

Watts Radiant

Radiant Floors & Snowmelting

Ph: 417/864.6108

Fax: 417/864.8161

GENERAL NOTES:





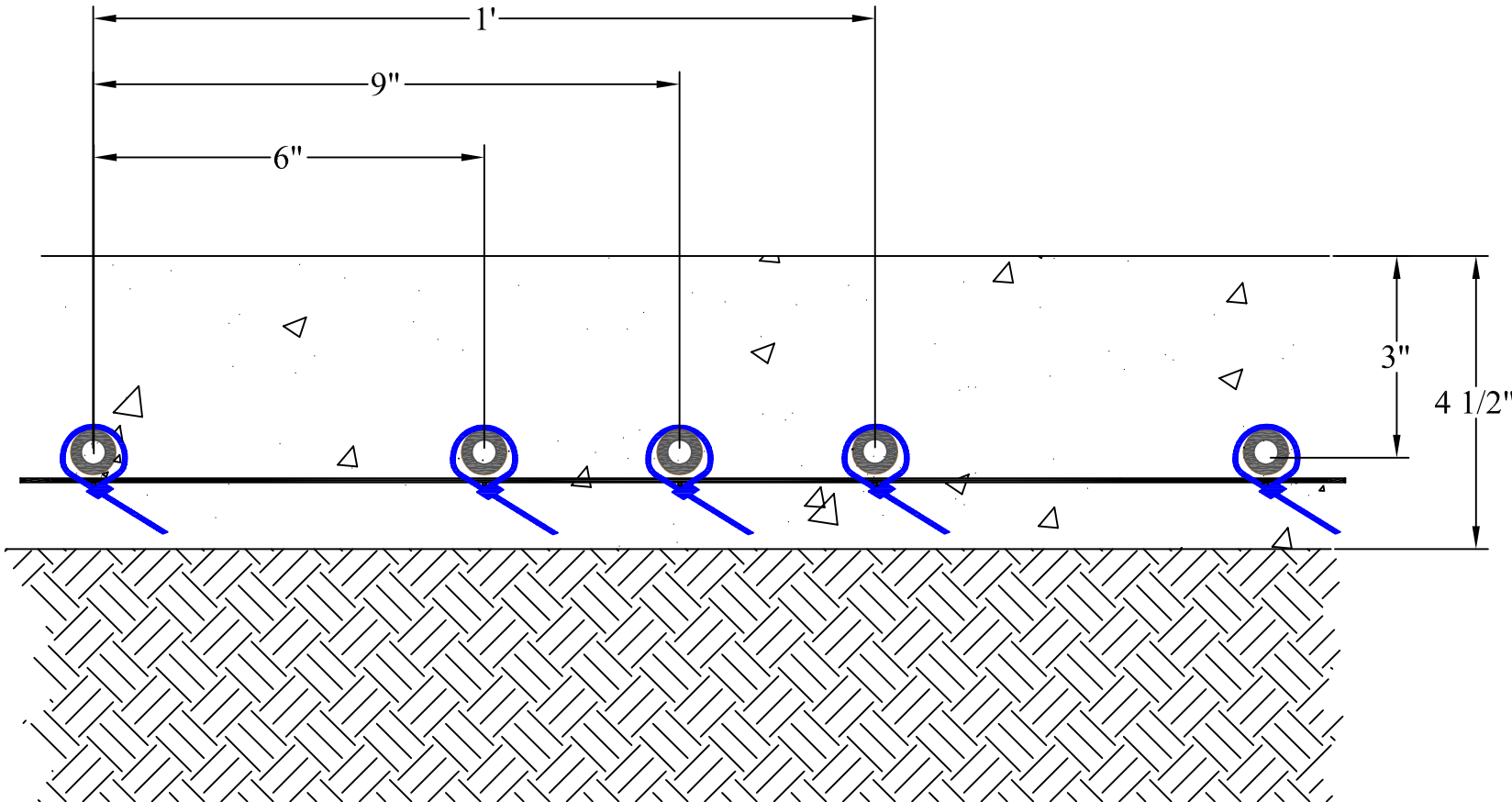

Cross sections are intended to illustrate typical radiant installations. Floor construction details shown are to be used for illustrative purposes only, not for actual construction. Structural details will need to be determined by the project engineer, architect or other.

SPECIFIER INFORMATION:



ONIX CROSS SECTIONAL DETAILS:

General Legend

-  Concrete (Thin Slab)/ Mud
-  Joist/Sleepers
-  Plywood
-  Sand Fill
-  Board/Batt Insulation
-  Gravel Bed/Earth Fill

SLAB SNOWMELT

Watts Radiant

Radiant Floors & Snowmelting

Ph: 417/864.6108

Fax: 417/864.8161

GENERAL NOTES:





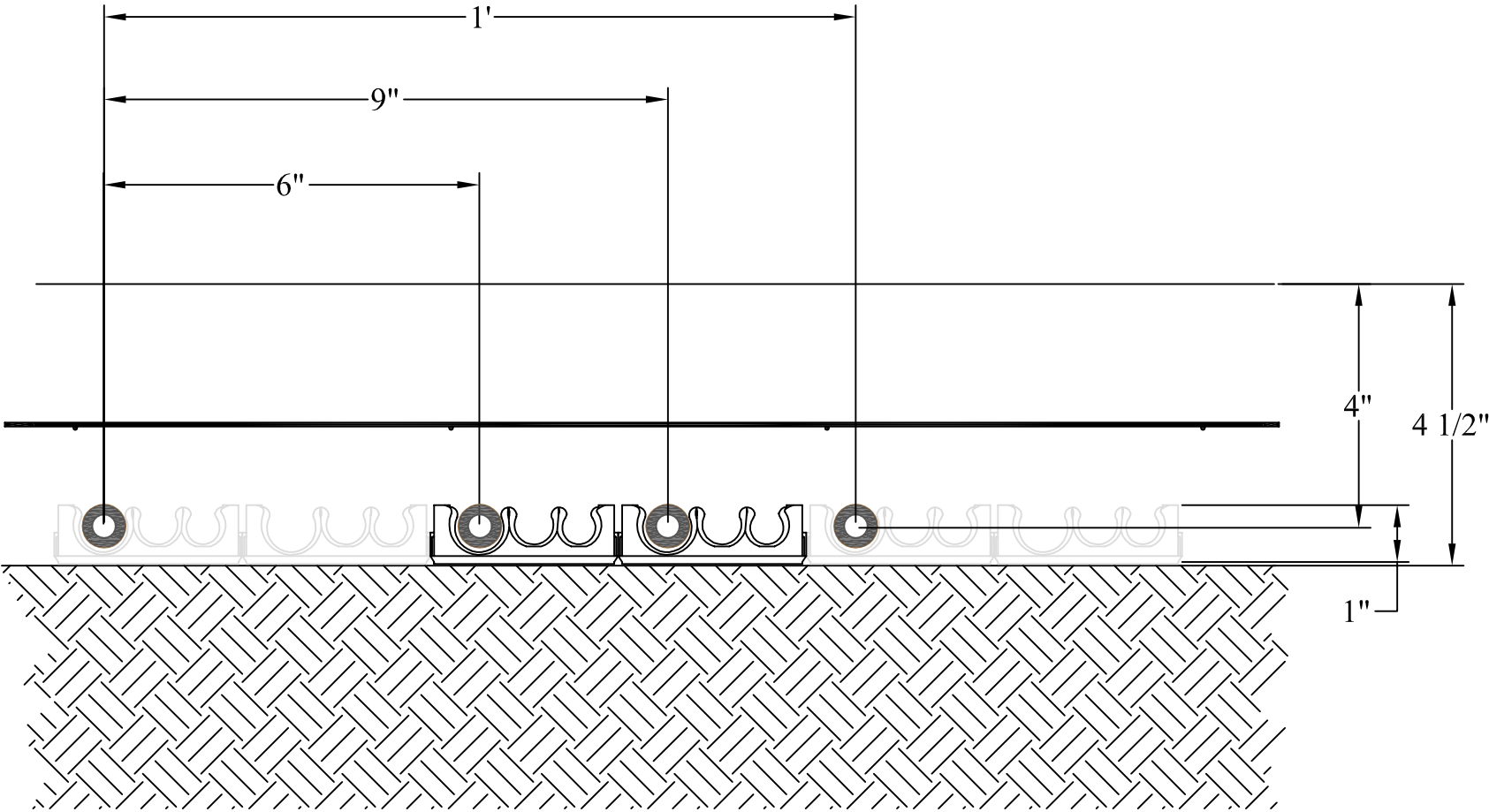

Cross sections are intended to illustrate typical radiant installations. Floor construction details shown are to be used for illustrative purposes only, not for actual construction. Structural details will need to be determined by the project engineer, architect or other.

SPECIFIER INFORMATION:



ONIX CROSS SECTIONAL DETAILS:

General Legend

-  Concrete (Thin Slab)/ Mud
-  Joist/Sleepers
-  Plywood
-  Sand Fill
-  Board/Batt Insulation
-  Gravel Bed/Earth Fill

SAND & BRICK PAVER SNOWMELT

Watts Radiant

Radiant Floors & Snowmelting

Ph: 417/864.6108

Fax: 417/864.8161

GENERAL NOTES:





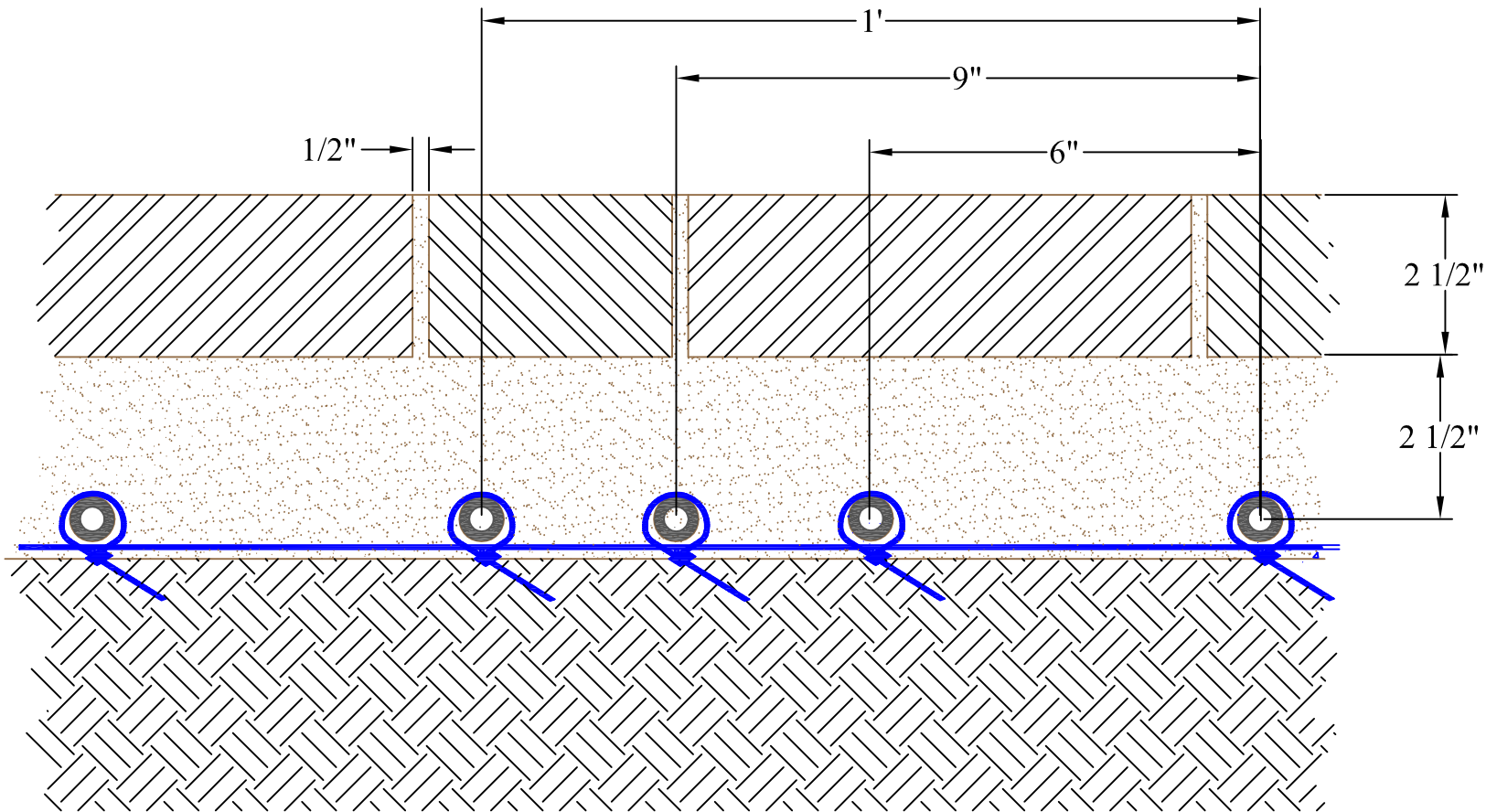

Cross sections are intended to illustrate typical radiant installations. Floor construction details shown are to be used for illustrative purposes only, not for actual construction. Structural details will need to be determined by the project engineer, architect or other.

SPECIFIER INFORMATION:



ONIX CROSS SECTIONAL DETAILS:

General Legend

-  Concrete (Thin Slab)/ Mud
-  Joist/Sleepers
-  Plywood
-  Sand Fill
-  Board/Batt Insulation
-  Gravel Bed/Earth Fill

ASPHALT SNOWMELT

Watts Radiant

Radiant Floors & Snowmelting

Ph: 417/864.6108

Fax: 417/864.8161







GENERAL NOTES:

Cross sections are intended to illustrate typical radiant installations. Floor construction details shown are to be used for illustrative purposes only, not for actual construction. Structural details will need to be determined by the project engineer, architect or other.

SPECIFIER INFORMATION:

ONIX CROSS SECTIONAL DETAILS:

General Legend

-  Concrete (Thin Slab)/ Mud
-  Joist/Sleepers
-  Plywood
-  Sand Fill
-  Board/ Batt Insulation
-  Gravel Bed/ Earth Fill

