

# tekmar®

## Programmable Thermostat 521

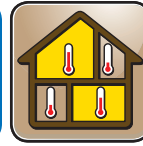

Zoning

521\_D

01/14

Replaces: New

# Installation & Operation Manual

## Introduction

The Programmable Thermostat 521 is designed for three different modes of operation: single stage heating, two stages of heating with a fan, or one stage of heating and one stage of cooling with a fan. Two auxiliary sensors may be added to measure the floor, outdoor or room temperature. A Slab Sensor 079 is included to measure floor temperature to protect the floor from overheating and enhance comfort. The programmable schedule supports either a 7 day or 24 hour schedule with 2 or 4 events per day. A permanent temperature hold button overrides the programmable schedule. An optional Adaptor Plate 012 is available to allow the thermostat to mount onto a single gage electrical box.

## Energy Saving Features

- 7 Day Programmable Schedule

## Additional Features

- Optimum Start
- Permanent Temperature Hold
- Radiant Floor Heating
- Two Stage Heating
- Cooling
- Fan
- Backlight
- Outdoor and Floor Temperature Display
- Time Clock
- Four Hour Battery-free Clock Backup

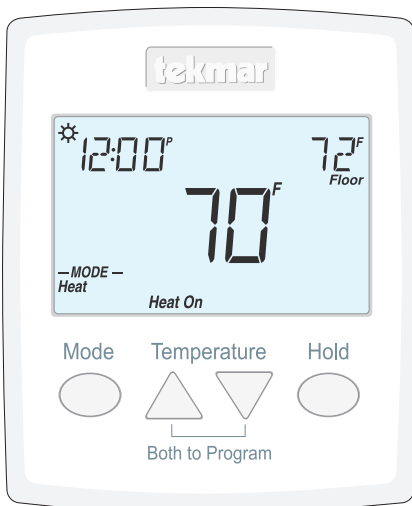

## Table of Contents

Getting Started .....	2	Sequence of Operation.....	22
Important Safety Information .....	3	Mode Button Operation .....	22
Installation .....	4	Heating Operation.....	22
Preparation .....	4	Cooling Operation.....	23
Removing The Thermostat Base....	4	Fan Operation.....	23
Mounting The Thermostat.....	5	Time Clock.....	24
Slab Sensor 079 Installation .....	6	Programmable Schedule .....	24
Slab Sensor 079 Wiring .....	7	Optimum Start.....	25
Slab Sensor 079 Testing .....	8	Temperature Adjustment .....	25
Temperature vs. Resistance Table... 8		Access Levels.....	25
Thermostat Wiring .....	9-11	Troubleshooting .....	26
Testing the Thermostat Wiring.....	12	Error Messages .....	26
Switch Settings .....	13	Frequently Asked Questions .....	27
User Interface .....	14	Technical Data .....	27
Home Screen.....	14	Limited Warranty and Product	
Symbols Description.....	14	Return Procedure .....	28
Programmable Settings .....	15		
Fan Menu.....	15		
Set Temp Menu.....	16		
Time Menu .....	17		
Schedule Menu.....	18-19		
Setup Menu.....	20-21		

## Getting Started

Congratulations on the purchase of your new tekmar® thermostat.

This manual will step through the complete installation, programming and sequence of operation for this control. At the back, there are tips for control and system troubleshooting.

# Important Safety Information

## WARNING



It is your responsibility to ensure that this control is safely installed according to all applicable codes and standards. tekmar is not responsible for damages resulting from improper installation and/or maintenance.

### To avoid serious personal injury and damage to the equipment:



- Read Manual and all product labels BEFORE using the equipment. Do not use unless you know the safe and proper operation of this equipment.
- Keep this Manual available for easy access by all users.
- Replacement Manuals are available at [tekmarControls.com](http://tekmarControls.com)



- Disconnect all power before opening the control.

- It is the installers responsibility to ensure that this control is safely installed according to all applicable codes and standards.
- Improper installation and operation of this control could result in damage to the equipment and possibly even personal injury or death.
- This electronic control is not intended for use as a primary limit control. Other controls that are intended and certified as safety limits must be placed into the control circuit.
- Do not attempt to service the control. There are no user serviceable parts inside the control. Attempting to do so voids warranty.

# Installation

## Preparation

### Tools Required

- tekmar or jeweller screwdriver
- Wire Stripper
- Phillips head screwdriver

### Materials Required

- 18 AWG LVT Solid Wire  
(Low Voltage Connections)

### Installation Location

Choose the placement of the thermostats early in the construction process to enable proper wiring during rough-in.

Consider the following:

- Interior Wall.
- Keep dry. Avoid potential leakage onto the control.
- Relative Humidity less than 90%. Non-condensing environment.
- No exposure to extreme temperatures beyond 32-122°F (0-50°C).
- No draft, direct sun, or other cause for inaccurate temperature readings.
- Away from equipment, appliances, or other sources of electrical interference.
- Easy access for wiring, viewing, and adjusting the display screen.
- Approximately 5 feet (1.5 m) off the finished floor.
- The maximum length of wire is 500 feet (150 m).
- Strip wire to 3/8" (10 mm) for all terminal connections.
- Use standard 5 conductor, 18 AWG wire.

## Removing The Thermostat Base

To remove the thermostat base:

- Locate the tab on the bottom of the thermostat.
- Push the tab with either your thumb or with a screwdriver.
- Lift the thermostat front away from the thermostat's base.

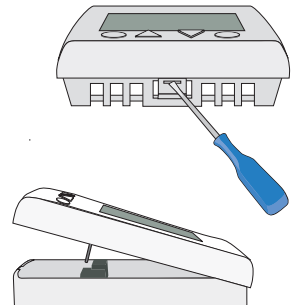

## Mounting The Thermostat

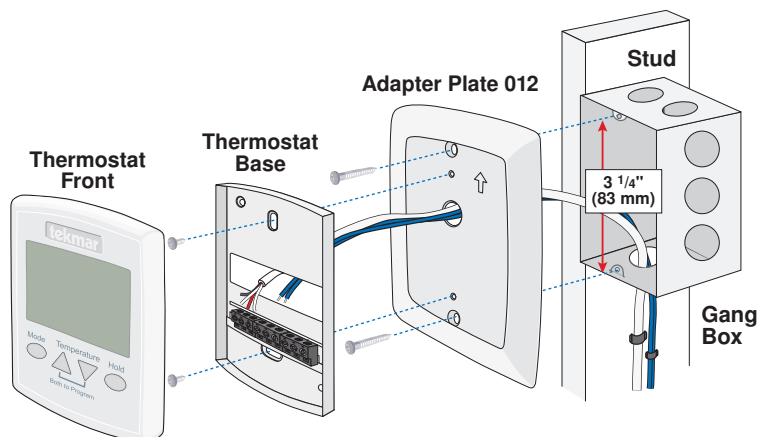

If a single gang box is used:

- Adapter Plate 012 is required (sold separately).
- Feed the wiring through the hole in the adaptor plate and the thermostat base.
- Fasten the adaptor plate to the gang box.
- Fasten the base of the thermostat to the adaptor plate.
- Terminate wiring to the wiring strip.
- Push the thermostat front onto the thermostat base.

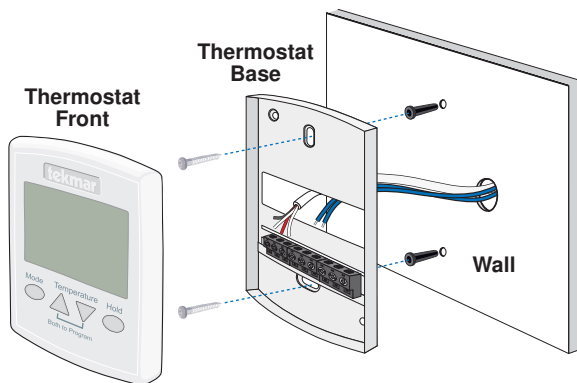

If mounting directly to the wall:

- Drill holes and install the wall anchors.
- Feed the wiring through the large hole in the thermostat base.
- Fasten the thermostat base to the wall using the wood screws to the wall anchors.
- Terminate wiring to the wiring strip.
- Push the thermostat front onto the thermostat base.

## Slab Sensor 079 Installation

### New Installations

#### Thin-Set or Thin-Pour Applications

If the floor covering is to be installed over either a thin-set or thin-pour material of sufficient depth, the 079 slab sensor can be placed directly into either the thin-set material or the thin-pour material and covered over. Ensure that the sensor is located in such a position that the attached wire is able to reach to a suitable junction location. Splices within the thin-set or thin-pour should be avoided to ensure trouble free operation. The sensor should be located mid way between the heating elements to ensure a proper temperature reading.

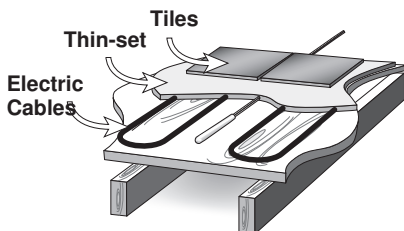

#### Thin Floor Coverings (less than 3/8" (10 mm))

If a thin floor covering is to be installed directly to the subfloor, a groove 1/8" (4 mm) wide by 1/16" (2 mm) deep can be cut into the surface of the subfloor to accommodate the wire for the sensor. Ensure that the sensor is located in such a position that the attached wire is able to reach to a suitable junction location. Splices under the floor covering should be avoided to ensure trouble free operation. A groove 3/16" (5 mm) wide by 3/16" (5 mm) deep by 1-3/4" (45 mm) long should be cut to accommodate the sensor. The sensor should be located mid way between the heating elements to ensure a proper temperature reading.

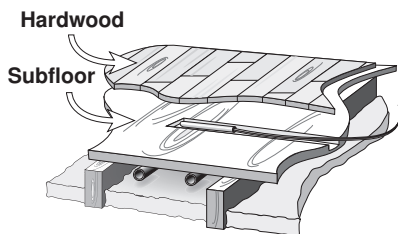

#### Thick Floor Coverings (greater than 3/8" (10 mm))

If a thick floor covering is to be installed directly to the subfloor, a groove 1/8" (4 mm) wide by 1/16" (2 mm) deep can be cut into the back of the flooring material to accommodate the wire for the sensor. Ensure that the sensor is located in such a position that the attached wire is able to reach to a suitable junction location.

Splices under the floor covering should be avoided to ensure trouble free operation. A groove 3/16" (5 mm) wide by 3/16" (5 mm) deep by 1-3/4" (45 mm) long should be cut to accommodate the sensor. The sensor should be located mid way between the heating elements to ensure a proper temperature reading.

If it is not practical to cut a groove in the surface covering, follow the installation method used for thin floor coverings.

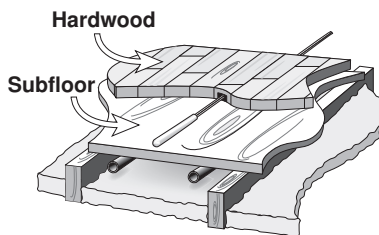

## Retrofit Installations

---

### Tile Floor Coverings

If a Slab Sensor 079 is to be installed into an existing tile floor with sufficiently large grout lines, the sensor and wire can be installed in one of the grout lines between the tiles. Select a low traffic area of the floor that is mid way between the heating elements for the sensor location. Ensure that the sensor is located in such a position that the attached wire is able to reach to a suitable junction location. Splices within the grout should be avoided to ensure trouble free operation. Remove the appropriate grout line and place the sensor and wire in the floor. Re-grout the area.

### Installing the Sensor to the Bottom of a Subfloor

If the sensor is to be installed to the bottom of a subfloor, cut a piece of 1" (25 mm) thick rigid insulation into a 6" (150 mm) by 6" (150 mm) square. A groove 3/16" (5 mm) wide by 3/16" (5 mm) deep by 1-3/4" (45 mm) long should be cut into the insulation to accommodate the sensor. Place the sensor in the groove and sandwich the sensor between the insulation and the subfloor. Use a suitable fastening method to affix the insulation to the subfloor.

#### **NOTICE**

Do not run sensor wires parallel to telephone or power cables. If the sensor wires are located in an area with strong sources of electromagnetic interference, shielded cable or twisted pair should be used or the wires can be run in a grounded metal conduit.

### Slab Sensor 079 Wiring

The Slab Sensor 079 is supplied with 10' (3 m) of cable. If a longer length is required, 24 AWG or larger wire can be spliced onto the two wires from the sensor. The splices should be properly soldered and protected in an accessible junction box. Follow the sensor testing instructions given in this brochure and then connect the wires to the control.

## Slab Sensor 079 Testing

A good quality test meter capable of measuring up to 5,000 k $\Omega$  (1 k $\Omega$  = 1000 $\Omega$ ) is required to measure the sensor resistance. In addition to this, the actual temperature must be measured with either a good quality digital thermometer, or if a thermometer is not available, a second sensor can be placed alongside the one to be tested and the readings compared.

First measure the room temperature using the thermometer. Disconnect the S1 or S2 and Com wires from the thermostat. Using an electrical meter, measure the resistance of the S1 or S2 and Com wires at the thermostat location. Using the temperature versus resistance table, estimate the temperature measured by the sensor. The sensor measurement and thermometer readings should be close. If the test meter reads a very high resistance, there may be a broken wire, a poor wiring connection or a defective sensor. If the resistance is very low, the wiring may be shorted, there may be moisture in the sensor or the sensor may be defective. To test for a defective sensor, measure the resistance directly at the sensor location. Once the test has been completed, reconnect the S1 or S2 and Com wires to the thermostat.

Do not apply voltage to the temperature sensor terminals at any time as damage to the sensor may result.

## Temperature vs. Resistance Table

Temperature		Resistance
°F	°C	$\Omega$
-50	-46	490,813
-45	-43	405,710
-40	-40	336,606
-35	-37	280,279
-30	-34	234,196
-25	-32	196,358
-20	-29	165,180
-15	-26	139,402
-10	-23	118,018
-5	-21	100,221
0	-18	85,362
5	-15	72,918
10	-12	62,465
15	-9	53,658
20	-7	46,218

Temperature		Resistance
°F	°C	$\Omega$
25	-4	39,913
30	-1	34,558
35	2	29,996
40	4	26,099
45	7	22,763
50	10	19,900
55	13	17,436
60	16	15,311
65	18	13,474
70	21	11,883
75	24	10,501
80	27	9,299
85	29	8,250
90	32	7,334
95	35	6,532



## Temperature vs. Resistance Table - Continued

Temperature		Resistance
°F	°C	Ω
100	38	5,828
105	41	5,210
110	43	4,665
115	46	4,184
120	49	3,760
125	52	3,383
130	54	3,050
135	57	2,754
140	60	2,490
145	63	2,255
150	66	2,045
155	68	1,857
160	71	1,689

Temperature		Resistance
°F	°C	Ω
165	74	1,538
170	77	1,403
175	79	1,281
180	82	1,172
185	85	1,073
190	88	983
195	91	903
200	93	829
205	96	763
210	99	703
215	102	648
220	104	598
225	107	553

## Thermostat Wiring

### Zone Valve

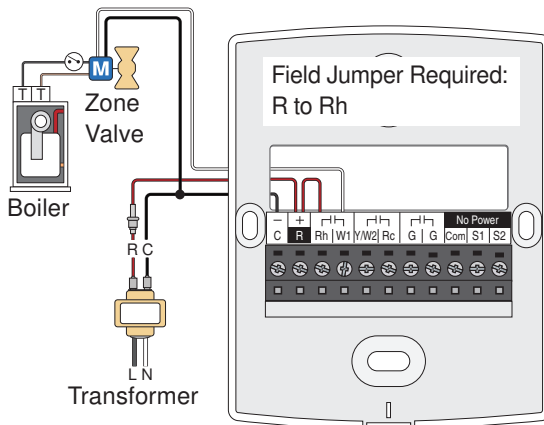

# Thermostat Wiring

## Relay 003

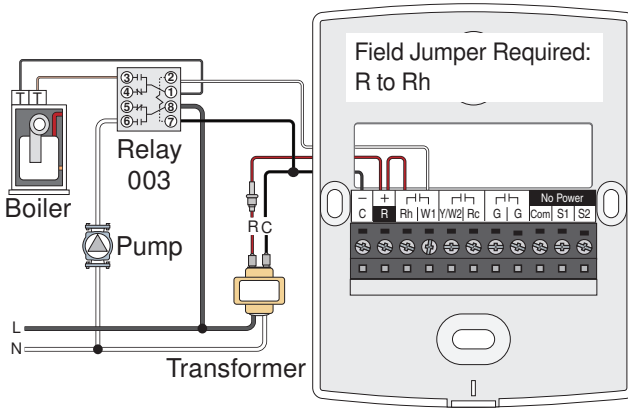

## Wiring Center 315 or 316

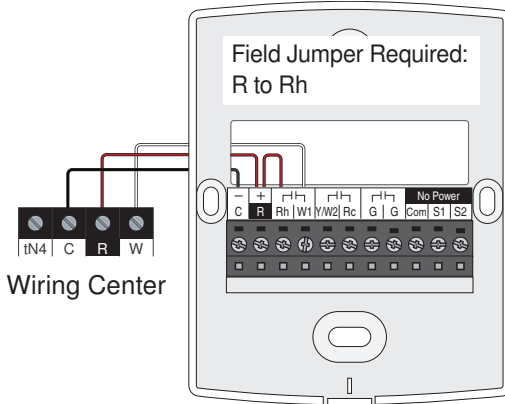

## Switching Relay

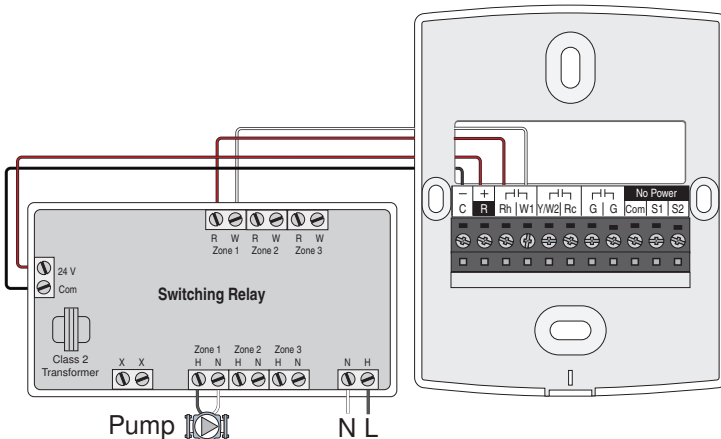

# Thermostat Wiring

## Air Conditioner

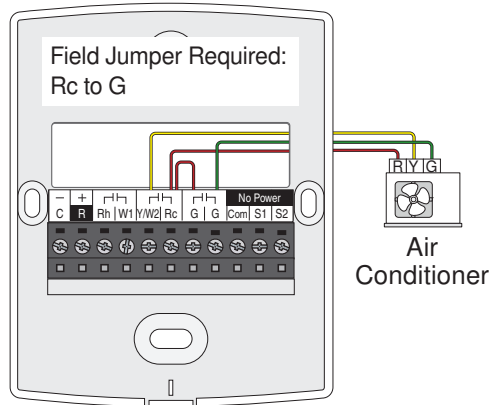

## Furnace (second stage heat)

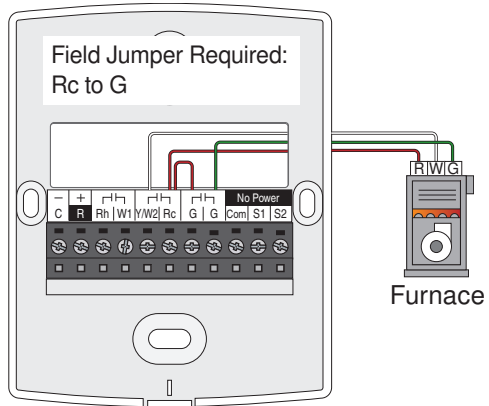

## Furnace and Air Conditioner

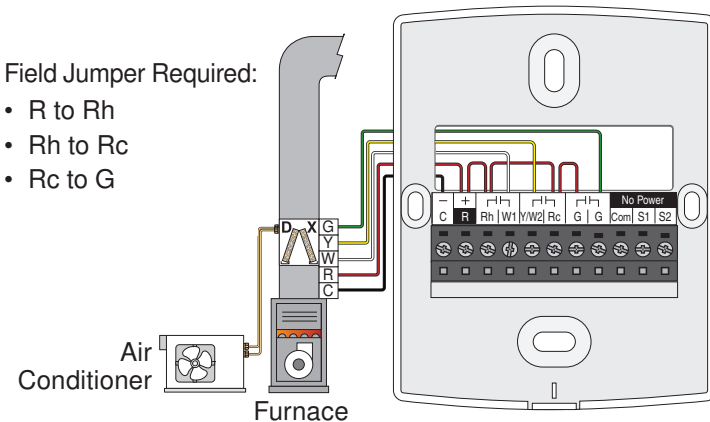

## Sensors

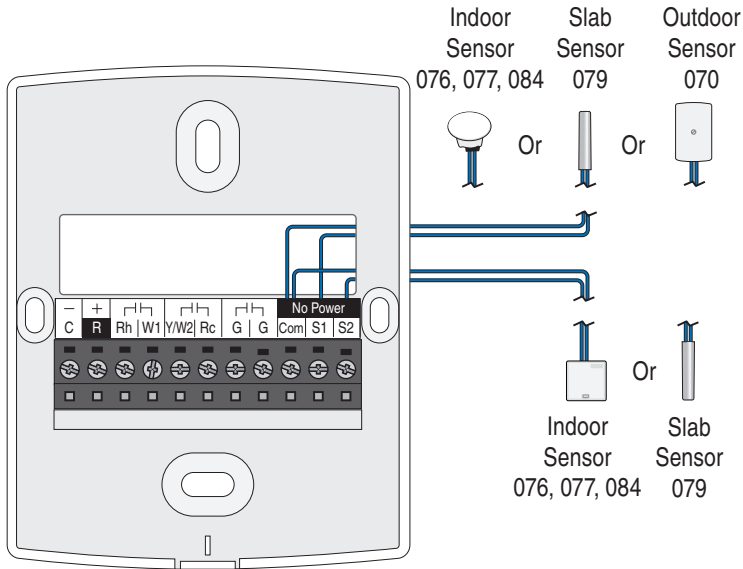

## Testing the Thermostat Wiring

### Testing the Power

If the thermostat display turns on, this indicates that power is applied correctly. In the event that the display is permanently off:

1. Remove the thermostat front.
2. Use an electrical meter to measure voltage between the R and C wiring terminals. For AC power supplies the voltage should measure between 10 to 30 V (ac). For DC power supplies the voltage should measure between 10 to 30 V (dc).
3. If the voltage on the R and C wire terminations is continuous and the thermostat display is not on, the thermostat may have a fault. Contact your tekmar sales representative for assistance.

If the thermostat display initially powers on but later shuts off intermittently, there may be a short circuit from the W1, W2, Y or G wire to the power common or ground, or the power supply is too small to power the load.

### Testing the First Stage Heat Output Wiring

1. Press the Mode button and set to Heat.
2. Press the  $\Delta$  button and set the heating temperature above the current room temperature. Make sure the display does not flash "Max" if using a floor sensor.
3. When the "Heat On" symbol appears on the display, use an electrical meter to check for voltage on the W1 and C wires connected to the zone valve, wiring center, relay or switching relay. The electrical meter should read 10 to 30 V (ac) or (dc).
4. If the W1 and C wires have voltage, check the zone valve, wiring center, relay or pump to determine if the heat device is operating correctly.

## Testing the Cooling Output Wiring

Cooling is only available when the switch setting is set to H/C/F.

1. Press the Mode button and set to Cool.
2. Press the ▽ button and set the cooling temperature below the current room temperature setting.
3. When the “Cool On” symbol appears on the display, use an electrical meter to check for voltage on the Y and C wires on the cooling equipment. The meter should read 10 to 30 V (ac) or (dc).

## Testing the Fan Output Wiring

The fan is only available when the Fan Mode setting is not set to off.

1. Press both the △ and ▽ buttons together.
2. The display will show FAN MENU. Press the PRGM button.
3. Press the up button to set the fan to On.
4. When the fan symbol appears on the display, use an electrical meter to check for voltage on the G and C wires on the fan equipment. The meter should read 10 to 30 V (ac) or (dc).

## Switch Settings

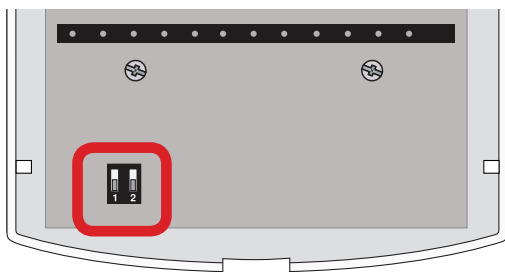

Switch	Position	Action
1	ON	<b>LOCK ACCESS LEVEL</b> Thermostat is locked and the access level cannot be changed. Set to Lock when installation has been completed.
	OFF	<b>UNLOCK ACCESS LEVEL</b> Thermostat is unlocked and the access level may be changed. Go to the Setup menu to change the access level. Set to Unlock during the installation process.
2	ON	<b>H/C/F</b> Thermostat is configured to operate one stage heating, one stage cooling and fan.
	OFF	<b>1H OR 2H</b> Thermostat is configured to operate one or two stage heating with a fan.

# User Interface

## Home Screen

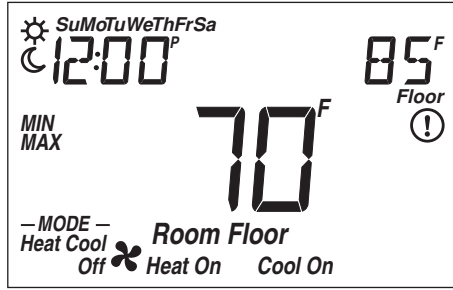

**Mode Button**  
Change operation from Heat, Cool and Off.



Mode



Temperature





Both to Program



Hold

**Hold Button**  
Permanently overrides the schedule. Press hold to cancel.

## Symbols Description

<b>Heat On</b>	<b>HEAT ON</b> Heat is turned on.		<b>SUN</b> Schedule operating at the occupied temperature.
<b>Cool On</b>	<b>COOL ON</b> Cooling is turned on.		<b>MOON</b> Schedule operating at the unoccupied temperature.
	<b>FAN</b> The fan is turned on.		<b>WARNING SYMBOL</b> Indicates an error is present.
<b>—MODE— Heat</b>	<b>MODE HEAT</b> The heating system is allowed to operate.	<b>HOLD</b>	<b>HOLD</b> Permanently holds the temperature and overrides the schedule.
<b>—MODE— Cool</b>	<b>MODE COOL</b> The cooling system is allowed to operate.	<b>MIN</b>	<b>MIN</b> The floor is at or below the floor minimum temperature.
<b>—MODE— Off</b>	<b>MODE OFF</b> The heating and cooling systems are off.	<b>MAX</b>	<b>MAX</b> The floor has reached the floor maximum temperature.

# Programmable Settings

## Navigation

1. Press and hold down both the  $\triangle$  and  $\nabla$  buttons together to enter the Programming Menu.

2. While in the Programming Menu, the MODE button changes function to become the MENU button.  
**Press the MENU button to change from one menu to the next.**

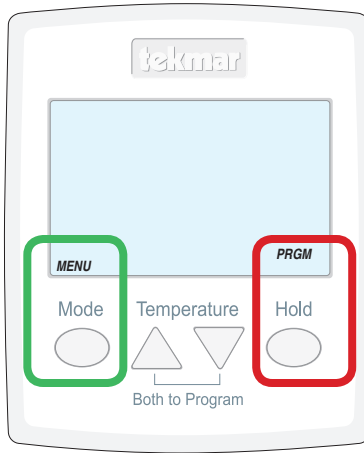

3. While in the Programming Menus, the HOLD button changes function to become the PRGM (program) button.  
**Press the PRGM button to enter the menu.**

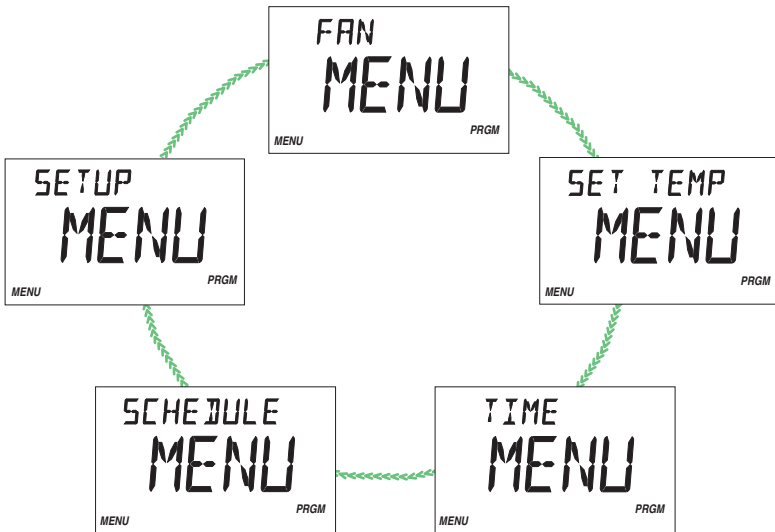

4. While inside a menu, the HOLD button changes to become the ITEM button.  
**Press the ITEM button to change from one setting to the next.**
5. Press the  $\triangle$  or  $\nabla$  button to change and save the setting's value.

Fan Menu	
Setting	Display
<b>FAN</b> Select if the fan should operate continuously (On) or only together with the heating or cooling equipment (Auto).	<b>FAN</b>
Access Level: Installer, User	Range: Auto or On
Conditions: Only available when FAN MODE is not set to OFF and a room temperature sensor is available.	Default: Auto

Set Temp Menu	
Setting	Display
<b>SET HEAT ROOM ☼</b> Set the room heating temperature for the ☼ event.	☼ <b>SET HEAT</b>
Access Level: Installer, User	Range: 40 to 95°F (4.5 to 35.0°C)
Conditions: Room Sensor On or Sensor 1 or 2 is set to Room.	Default: 70°F (21.0°C)
<b>SET HEAT ROOM ☾</b> Set the room heating temperature for the ☾ event.	☾ <b>SET HEAT</b>
Access Level: Installer, User	Range: 40 to 95°F (4.5 to 35.0°C)
Conditions: Room Sensor On or Sensor 1 or 2 is set to Room and Schedule is set to On.	Default: 65°F (18.5°C)
<b>SET COOL ROOM ☼</b> Set the room cooling temperature for the ☼ event.	☼ <b>SET COOL</b>
Access Level: Installer, User	Range: 50 to 100°F (10.0 to 38.0°C)
Conditions: Room Sensor On or Sensor 1 or 2 is set to Room.	Default: 78°F (25.5°C)
<b>SET COOL ROOM ☾</b> Set the room cooling temperature for the ☾ event.	☾ <b>SET COOL</b>
Access Level: Installer, User	Range: 50 to 100°F (10.0 to 38.0°C)
Conditions: Room Sensor On or Sensor 1 or 2 is set to Room and Schedule is set to On.	Default: 85°F (29.5°C)
<b>SET FLOOR ☼</b> Set the floor heating temperature for the ☼ event.	☼ <b>SET FLOOR</b>
Access Level: Installer, User	Range: OFF, 40 to 122°F (OFF, 4.5 to 50.0°C)
Conditions: Sensor 1 or 2 is set to Floor.	Default: 72°F (22.0°C)



## Set Temp Menu





Setting	Display
<b>SET FLOOR</b> Set the floor heating temperature for the  event.	<b>SET FLOOR</b>
Access Level: Installer, User	Range: OFF, 40 to 122°F (OFF, 4.5 to 50.0°C)
Conditions: Sensor 1 or 2 is set to Floor and Schedule is set to On.	Defaults Air & floor sensors: 65°F (18.5°C) Floor sensor only: OFF
<b>SET FLOOR MAXIMUM</b> Set the maximum floor heating temperature.	<b>SET FLOOR</b> <small>MAX</small>
Access Level: Installer	Range: 40 to 122°F, OFF (4.5 to 50.0°C, OFF)
Conditions: Sensor 1 or 2 is set to Floor.	Default: 85°F (29.5°C)

## Time Menu

Setting	Display
<b>MINUTES</b> Set the current time minutes.	<b>12:00</b>
Access Level: Installer, User	Range: 00 to 59
Conditions: Always available.	Default: 00
<b>HOURS</b> Set the current time hours.	<b>12:00</b>
Access Level: Installer, User	Range: 12 AM to 11 PM or 00 to 23
Conditions: Always available.	Default: 12 AM
<b>DAY OF WEEK</b> Select the current day of the week.	<b>MONDAY</b>
Access Level: Installer, User	Range: Sunday to Saturday
Conditions: Always available.	Default: Sunday
<b>TIME MODE</b> Select either 12 or 24 hour time format.	<b>TIME MODE</b>
Access Level: Installer, User	Range: 12 or 24 hour
Conditions: Always available.	Default: 12 hour
<b>CLOCK</b> Select whether to show the time clock on the display.	<b>CLOCK</b>
Access Level: Installer, User	Range: OFF or ON
Conditions: The time is always shown when a schedule is used and the clock setting option is hidden.	Default: OFF

## Schedule Menu (1 of 2)

The schedule menu can operate on a 24 hour or 7 day repeating schedule. When a 24 hour schedule is selected, "SuMoTuWeThFrSa" is shown on the top of the screen to show that the event time applies to all days of the week. When a 7 day schedule is selected, each individual day of the week is shown with the event time.

Setting	Display
<b>EVENT 1</b> The first programmable schedule time period of the day. The ☼ temperature settings are used during this time period.	
Access Level: Installer, User	Range: 12:00 AM to 11:50 PM, SKIP or 00:00 to 23:50, SKIP
Conditions: Schedule setting is set to On.	Default: 6:00 AM
<b>EVENT 2</b> The second programmable schedule time period of the day. The ☾ temperature settings are used during this time period.	
Access Level: Installer, User	Range: 12:00 AM to 11:50 PM, SKIP or 00:00 to 23:50, SKIP
Conditions: Schedule setting is set to On.	Default: 10:00 PM when Event/Day is 2 8:00 AM when Event/Day is 4
<b>EVENT 3</b> The third programmable schedule time period of the day. The ☼ temperature settings are used during this time period.	
Access Level: Installer, User	Range: 12:00 AM to 11:50 PM, SKIP or 00:00 to 23:50, SKIP
Conditions: Schedule setting is set to On.	Default: 6:00 PM
<b>EVENT 4</b> The fourth programmable schedule time period of the day. The ☾ temperature settings are used during this time period.	
Access Level: Installer, User	Range: 12:00 AM to 11:50 PM, SKIP or 00:00 to 23:50, SKIP
Conditions: Schedule setting is set to On.	Default: 10:00 PM

Schedule Menu (2 of 2)	
Setting	Display
<b>SCHEDULE</b> Select if the thermostat should change the temperature automatically using a programmable schedule.	SCHEDULE
Access Level: Installer, User	Range: OFF or On
Conditions: Always available	Default: OFF
<b>EVENT PER DAY</b> Select either two or four scheduled events per day.	EVENT / DAY
Access Level: Installer, User	Range: 2 or 4
Conditions: Schedule setting is set to On.	Default: 2
<b>24 HOUR / 7 DAY</b> Select either a 24 hour or a 7 day repeatable schedule.	24hr / 7DAY
Access Level: Installer, User	Range: 24 hour or 7 day
Conditions: Schedule setting is set to On.	Default: 24 hour
<b>OPTIMUM START</b> Select whether or not to use optimum start. The thermostat learns the heat up rate of the room and starts heating in advance of Event 1 or Event 3. Only applies to radiant floor heating, baseboard or radiator heating.	OPT START
Access Level: Installer, User	Range: OFF or ON
Conditions: Schedule setting is set to On.	Default: ON

Setup Menu (1 of 2)	
Setting	Display
<b>ACCESS</b> Selects the access level of the thermostat, which determines which menus and items are available.	<b>ACCESS</b>
Access Level: Installer, User	Range: Installer or User
Conditions: Only available when switch setting 1 is set to Unlocked.	Default: Installer
<b>UNITS</b> Select the temperature units.	<b>UNITS</b>
Access Level: Installer, User	Range: °F or °C
Conditions: Always available.	Default: °F
<b>LIGHT</b> Select when the display back light should operate. Auto operates the back light for 30 seconds after a keystroke.	<b>LIGHT</b>
Access Level: Installer, User	Range: OFF, AUTO, ON
Conditions: Always available.	Default: AUTO
<b>TYPE</b> Device Type number. Hold the $\Delta$ button to view the software version.	<b>TYPE</b>
Access Level: Installer, User	Range: 521
Conditions: Always available.	Default: 521
<b>SENSOR 1</b> Select the type of auxiliary sensor 1.	<b>SENSOR 1</b>
Access Level: Installer	Range: NONE, ROOM, FLOR (floor), OUT (Outdoor)
Conditions: Available when a sensor is automatically detected on auxiliary sensor 1 input.	Default: FLOR
<b>SENSOR 2</b> Select the type of auxiliary sensor 2.	<b>SENSOR 2</b>
Access Level: Installer	Range: NONE, ROOM, FLOR (floor)
Conditions: Available when a sensor is automatically detected on auxiliary sensor 2 input.	Default: ROOM
<b>ROOM SENSOR</b> Select if the built-in room temperature sensor is on or off.	<b>SENSOR</b> <i>Room</i>
Access Level: Installer	Range: OFF or ON
Conditions: When switch setting 2 is set to 1H or 2H, an auxiliary sensor must be set to Room or Floor. When switch setting 2 is set to H/C/F, an auxiliary sensor must be set to Room.	Default: ON

## Setup Menu (2 of 2)

Setting	Display
<b>W2 RELAY</b> Select if a second stage heat is available.	<b>W2 RELAY</b>
Access Level: Installer	Range: OFF or On
Conditions: Available when switch setting 2 is set to 1H or 2H.	Default: OFF
<b>W2 DELAY</b> Select the time delay that the second stage must wait before turning on.	<b>W2 DELAY</b>
Access Level: Installer	Range: 1 to 180 minutes
Conditions: Available when switch setting 2 is set to 1H or 2H and W2 Relay is set to On.	Default: 20 minutes
<b>W2 DIFFERENTIAL</b> Select the differential below the Set Heat setpoint at which the second stage heat can turn on.	<b>W2 DIFF</b>
Access Level: Installer, User	Range: 1.5 to 8.0°F (1.5 to 8.0°C)
Conditions: Available when switch setting 2 is set to 1H or 2H and W2 Relay is set to On.	Default: 2.0°F
<b>FAN MODE</b> Select how the fan should operate together with the W1, W2 and Y relays.	<b>FAN MODE</b>
Access Level: Installer, User	Range: OFF, Y, W1, W1+Y (Switch setting is H/C/F)  OFF, W1, W2, W1+2 (Switch setting is 1H or 2H)
Conditions: When switch setting 2 is set to H/C/F, always available. When switch setting 2 is set to 1H or 2H, available when a room sensor is available. If a floor sensor is available then W2 must also be set to On. Fan mode combinations with W1 are unavailable when a floor sensor is connected.	Default: Y (Switch setting 2 is H/C/F) OFF (Switch setting 2 is 1H or 2H)

# Sequence of Operation

## Mode Button Operation

Pressing the Mode button selects the operation of the thermostat to be either Heating, Cooling, or Off. The thermostat must be configured for heat/cool/fan operation in order for the cooling operation to be available.

## Heating Operation

Heating is available when the Mode is set to Heat. To change the heat temperature setting, push the  $\Delta$  or  $\nabla$  button to select a preferred temperature setting for the current schedule time period. The Heat On symbol is shown on the display when the thermostat is heating.

To change the temperatures for the other time periods, enter the Set Temp menu by pressing both the  $\Delta$  and  $\nabla$  buttons together, press Menu to locate the Set Temp menu, and press PRGM to enter the menu.

## Hydronic Systems

When operating a hydronic radiant floor, baseboard or radiator heating system, the thermostat uses Pulse Width Modulation (PWM) operation and cycles the heat on and off within  $\pm 1.5^{\circ}\text{F}$  ( $1^{\circ}\text{C}$ ) of the temperature setting.

## Forced Air Systems

When operating a forced air heating system, the thermostat uses a differential of  $\pm 0.7^{\circ}\text{F}$  ( $0.4^{\circ}\text{C}$ ).

## Temperature Sensor Location

The thermostat can operate the heating system based upon either an air temperature sensor, a floor temperature sensor, or a combination of both the air and floor temperature sensors together.

### Air Temperature Only

If there is only an air temperature sensor (no floor sensor), the thermostat maintains the desired air temperature.

### Floor Temperature Only

If the air sensor has been disabled, the thermostat will only maintain floor temperature and ignore air temperature. This operation is recommended for areas such as bathrooms to ensure that tile floors are warm to the touch.

### Floor and Air Temperature

If the air sensor is turned on and a floor sensor is connected, the thermostat will maintain the desired air temperature as well as a minimum floor temperature.

This operation is recommended for areas with large windows that allow the sun to shine into a room and keep it warm without the need for heat. This can allow the floors to cool off during the afternoon. When the sun goes down, it can take a long time for the floors to get warm again. This may cause the room to cool off too much in the early evening. A floor minimum setting can help with this condition by maintaining a floor minimum temperature. Keep in mind the floor minimum temperature will override the air temperature, and if set too high, may overheat the room.

This operation is also recommended for rooms with hardwood floors. Setting floor minimum and maximum temperatures is a way of enhancing the comfort of the living space while protecting floor coverings.

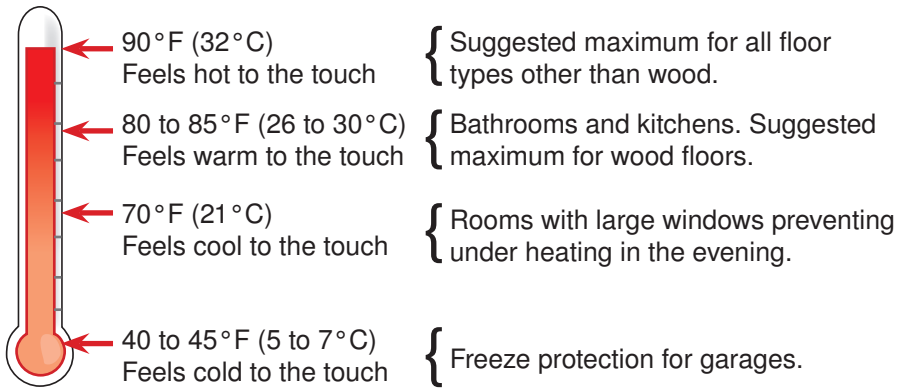

## Two-Stage Heating

The thermostat supports two-stage heating. The second stage heat turns on when the air temperature falls below the Set Heat minus the W2 Differential setting and the W2 Delay time expires. The second stage heat turns off when the room temperature reaches the Set Heat setting.

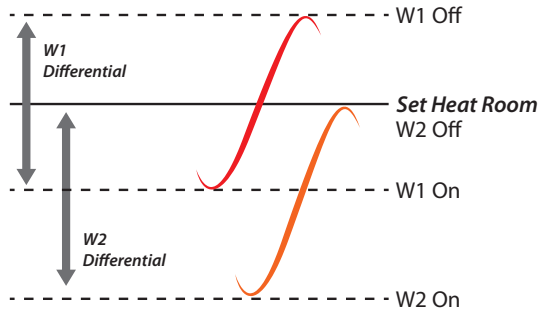

## Freeze Protection

The thermostat operates the heat whenever the room temperature falls below 40°F (4.5°C) even when the mode is set to off.

## Cooling Operation

Cooling is available when the Mode is set to Cool. The thermostat must be configured for heat/cool/fan operation in order for the cooling operation to be available.

To change the cool temperature setting, push the  $\Delta$  or  $\nabla$  button to select a preferred temperature setting for the current schedule time period. The Cool On symbol is shown on the display when the thermostat is cooling.

To change the temperatures for the other time periods, enter the Set Temp menu by pressing both the  $\Delta$  and  $\nabla$  buttons together, press Menu to locate the Set Temp menu, and press PRGM to enter the menu.

When operating a forced air cooling system, the thermostat uses a differential of +/- 0.7°F (0.4°C).

## Fan Operation

A fan is available when the thermostat operates a forced air heating or cooling system. The fan can be set to On to allow air circulation through the building. This is useful if the air in the room is stale or if circulating cool air from a basement throughout a home can reduce the temperature in the upper floor without operating the cooling equipment.

## Time Clock

The thermostat includes a time clock that is automatically visible in the Home menu when a programmable schedule is used. If the schedule is not used, the user has the option to select whether the time is shown in the Home menu.

**During a loss of power, the thermostat continues to keep the correct time and date for at least 4 hours.** If the power is off for more than 4 hours, the user will need to set the time.

## Programmable Schedule

Energy savings can be achieved by lowering the heating temperature and increasing the cooling temperature when the building is unoccupied or during the night.

When operating on a programmable schedule, a ☀ or a 🌙 symbol is shown in the home menu. The ☀ or 🌙 indicates the current operating temperature.

**All schedules are stored in permanent memory and are not affected by a loss of power.**

Display	Action
☀	Day temperature
🌙	Night temperature

This thermostat can operate on a programmable schedule in order to automatically lower the room temperature setting. The schedule can be off or on.

The thermostat can support schedules that have either:

- 2 events per day
- 4 events per day

Schedules with four events per day are common for residential use while two events per day are common for commercial installations.

The schedules can be repeated every:

- 24 hours
- 7 days (week)

A 7 day schedule allows a unique time to be set to change the temperature for each day of the week.

The schedule also includes a "SKIP" option that allows the programmable schedule to skip a temperature change and remain at the previous temperature setting. The "SKIP" setting can be found between 11:50 PM (23:50 hours) and 12:00 AM (0:00 hours).



## Optimum Start

When a programmable schedule is selected, there is a time delay for the room to warm up from the ☾ temperature to the ✨ temperature. The thermostat has the option to use Optimum Start to predict the heat up rate of the room. When Optimum Start is set to On, the heating is started in advance to allow the room to reach the Set Room temperature at the time set in the programmable schedule. The optimum start only applies to radiant floor heating, baseboard or radiator heating and does not apply when a forced air fan is used with the heating system.

## Temperature Adjustment

### Permanent Adjustment - No Schedule

When no programmable schedule is used, push the △ or ▽ buttons to permanently set the “Set Heat Room” or “Set Cool Room” temperature. This thermostat is capable of controlling both air and floor temperature.

### Permanent Adjustment - With Schedule

When a programmable schedule is used, there are two temperature settings available, one for the ✨ time period and another for the ☾ time period. When pushing the △ or ▽ buttons to change the temperature, only the temperature for the current time period is changed.

1. To adjust the temperature for both time periods, press and hold the △ and ▽ buttons for 3 seconds to enter the programming menus.
2. Enter the “SET TEMP” menu to adjust the following settings:
  - Set Heat Room ✨ (air heating)
  - Set Heat Room ☾ (air heating)
  - Set Floor ✨ (floor heating)
  - Set Floor ☾ (floor heating)
  - Set Cool Room ✨ (air cooling)
  - Set Cool Room ☾ (air cooling)

### Permanent Hold





The thermostat includes a Hold button. When the Hold button is pressed, the thermostat stops operating based on the programmable schedule and the hold temperature can be set using the △ or ▽ buttons. Press the Hold button a second time to cancel the hold and resume operating based upon the programmable schedule. If both an air and floor sensor are installed, the floor maintains the Set Floor ✨ temperature setting when the hold temperature is higher than the Set Heat Room ✨. When the hold temperature is set lower than the Set Heat Room ✨, the floor does not maintain a temperature.

## Access Levels

The thermostat has two access levels: User and Installer. The Installer access level provides access to all settings. The thermostat remains in the installer access level for up to 24 hours after which it automatically changes to the user access level.

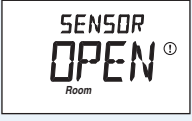
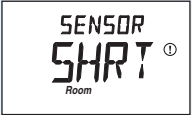
Once the thermostat has been installed, set the Lock / Unlock switch setting to Lock. This hides the access level setting and prevents unauthorized changes to the thermostat configuration settings.

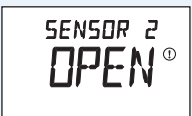
# Troubleshooting

Error Messages	
Error Message	Description
 <p>SETUP Err ⓘ</p>	<p><b>SETUP MENU SAVE ERROR</b></p> <p>The thermostat failed to read the Programmable Settings from memory and has reloaded the factory default settings. The thermostat stops normal operation until the access level is changed to Installer and all Programmable Settings are checked. The thermostat continues to provide freeze protection.</p>
 <p>SENSOR OPEN ⓘ Room</p>	<p><b>ROOM SENSOR OPEN CIRCUIT ERROR</b></p> <p>The built-in air temperature sensor has an open circuit fault. Do not confuse this error with the auxiliary room sensor short circuit error. This error cannot be field repaired. Contact your wholesaler or tekmar sales representative for details on repair procedures.</p>
 <p>SENSOR SHRT ⓘ Room</p>	<p><b>ROOM SENSOR SHORT CIRCUIT ERROR</b></p> <p>The built-in air temperature sensor has a short circuit fault. Do not confuse this error with the auxiliary room sensor short circuit error. This error cannot be field repaired. Contact your wholesaler or tekmar sales representative for details on repair procedures.</p>
 <p>SENSOR 1 OPEN ⓘ</p>	<p><b>AUXILIARY SENSOR 1 OPEN CIRCUIT ERROR</b></p> <p>The auxiliary sensor 1 has an open circuit. Check for loose or damaged wires. Locate and repair the problem as described in the Sensor Testing section of this brochure. The error clears after the auxiliary sensor fault is corrected. If the auxiliary sensor was intentionally removed, set access level to Installer and set Sensor 1 to None.</p>
 <p>SENSOR 1 SHRT ⓘ</p>	<p><b>AUXILIARY SENSOR 1 SHORT CIRCUIT ERROR</b></p> <p>The auxiliary sensor 1 has a short circuit. Check for damaged wires. Locate and repair the problem as described in the Sensor Testing section of this brochure. The error clears after the auxiliary sensor fault is corrected.</p>
 <p>SENSOR 2 OPEN ⓘ</p>	<p><b>AUXILIARY SENSOR 2 OPEN CIRCUIT ERROR</b></p> <p>The auxiliary sensor 2 has an open circuit. Check for loose or damaged wires. Locate and repair the problem as described in the Sensor Testing section of this brochure. The error clears after the auxiliary sensor fault is corrected. If the auxiliary sensor was intentionally removed, set access level to Installer and set Sensor 1 to None.</p>
 <p>SENSOR 2 SHRT ⓘ</p>	<p><b>AUXILIARY SENSOR 2 SHORT CIRCUIT ERROR</b></p> <p>The auxiliary sensor 2 has a short circuit. Check for damaged wires. Locate and repair the problem as described in the Sensor Testing section of this brochure. The error clears after the auxiliary sensor fault is corrected.</p>

## Frequently Asked Questions

Symptom	Look for...	Corrective Action
Display powering on and off.	Measure voltage at wiring terminals R and C.	The power supply transformer may have limited VA capacity. A transformer with a larger VA rating is recommended.
Heat not on	Mode Off or Cool	Thermostat must be in Mode Heat in order to provide heating.
	Floor Max	The floor has reached the maximum operating temperature.
Room is too hot due to floor heating being on	Floor Min	Lower the Set Floor temperature setting.
Cooling not on	Mode Off or Heat	Thermostat must be in Mode Cool in order to provide cooling.

## Technical Data

### Programmable Thermostat 521 *Two Heat or Heat-Cool (Includes Sensor 079)*

Literature	521_A, 521_C, 521_D, 521_Q, 521_U
Control	Microprocessor control. This is not a safety (limit) control
Packaged weight	0.6 lb. (290 g)
Dimensions	3-11/16" H x 3" W x 15/16" D (94 x 76 x 24 mm)
Enclosure	White PVC plastic, NEMA type 1
Approvals	Meets Class B: ICES & FCC Part 15, CE
Ambient conditions	Indoor use only, 32 to 122°F (0 to 50°C), RH ≤90% non-condensing
Power supply	10 to 30 V (ac/dc), 50/60 Hz, 1.8 VA, Class 2
Relay	30 V (ac/dc) 2 A, Class 2 circuits
Sensor	NTC thermistor, 10 kΩ @ 77°F (25°C ±0.2°C) β=3892
– Included	Slab Sensor 079
– Optional	tekmar type # 070, 072, 073, 076, 077, 079, 084

### Slab Sensor 079 *10' (3 m) wire*

Dimensions	3/16" OD x 1-1/2" (5 mm OD x 38 mm)
Enclosure	316 stainless steel, 10' (3 m) 24 AWG, 300 volt PVC insulated Zipcord
Approvals	CSA C US
Operating range	-58 to 221°F (-50 to 105°C)
Sensor	NTC thermistor, 10 kΩ @ 77°F (25°C ±0.2°C) β=3892

## Limited Warranty and Product Return Procedure

**Limited Warranty** *The liability of tekmar under this warranty is limited. The Purchaser, by taking receipt of any tekmar product ("Product"), acknowledges the terms of the Limited Warranty in effect at the time of such Product sale and acknowledges that it has read and understands same.*

The tekmar Limited Warranty to the Purchaser on the Products sold hereunder is a manufacturer's pass-through warranty which the Purchaser is authorized to pass through to its customers. Under the Limited Warranty, each tekmar Product is warranted against defects in workmanship and materials if the Product is installed and used in compliance with tekmar's instructions, ordinary wear and tear excepted. The pass-through warranty period is for a period of twenty-four (24) months from the production date if the Product is not installed during that period, or twelve (12) months from the documented date of installation if installed within twenty-four (24) months from the production date.

The liability of tekmar under the Limited Warranty shall be limited to, at tekmar's sole discretion: the cost of parts and labor provided by tekmar to repair defects in materials and / or workmanship of the defective product; or to the exchange of the defective product for a warranty replacement product; or to the granting of credit limited to the original cost of the defective product, and such repair, exchange or credit shall be the sole remedy available from tekmar, and, without limiting the foregoing in any way, tekmar is not responsible, in contract, tort or strict product liability, for any other losses, costs, expenses, inconveniences, or damages, whether direct, indirect, special, secondary, incidental or consequential, arising from ownership or use of the product, or from defects in workmanship or materials, including any liability for fundamental breach of contract.

The pass-through Limited Warranty applies only to those defective Products returned to tekmar during the warranty period. This Limited Warranty does not cover the cost of the parts or labor to remove or transport the defective Product, or to reinstall the repaired or replacement Product, all such costs and expenses being subject to Purchaser's agreement and warranty with its customers.

Any representations or warranties about the Products made by Purchaser to its customers which are different from or in excess of the tekmar Limited Warranty are the Purchaser's sole responsibility and obligation. Purchaser shall indemnify and hold tekmar harmless from and against any and all claims, liabilities and damages of any kind or nature which arise out of or are related to any such representations or warranties by Purchaser to its customers.

The pass-through Limited Warranty does not apply if the returned Product has been damaged by negligence by persons other than tekmar, accident, fire, Act of God, abuse or misuse; or has been damaged by modifications, alterations or attachments made subsequent to purchase which have not been authorized by tekmar; or if the Product was not installed in compliance with tekmar's instructions and / or the local codes and ordinances; or if due to defective installation of the Product; or if the Product was not used in compliance with tekmar's instructions.

THIS WARRANTY IS IN LIEU OF ALL OTHER WARRANTIES, EXPRESS OR IMPLIED, WHICH THE GOVERNING LAW ALLOWS PARTIES TO CONTRACTUALLY EXCLUDE, INCLUDING, WITHOUT LIMITATION, IMPLIED WARRANTIES OF MERCHANTABILITY AND FITNESS FOR A PARTICULAR PURPOSE, DURABILITY OR DESCRIPTION OF THE PRODUCT, ITS NON-INFRINGEMENT OF ANY RELEVANT PATENTS OR TRADEMARKS, AND ITS COMPLIANCE WITH OR NON-VIOLATION OF ANY APPLICABLE ENVIRONMENTAL, HEALTH OR SAFETY LEGISLATION; THE TERM OF ANY OTHER WARRANTY NOT HEREBY CONTRACTUALLY EXCLUDED IS LIMITED SUCH THAT IT SHALL NOT EXTEND BEYOND TWENTY-FOUR (24) MONTHS FROM THE PRODUCTION DATE, TO THE EXTENT THAT SUCH LIMITATION IS ALLOWED BY THE GOVERNING LAW.

**Product Warranty Return Procedure** All Products that are believed to have defects in workmanship or materials must be returned, together with a written description of the defect, to the tekmar Representative assigned to the territory in which such Product is located. If tekmar receives an inquiry from someone other than a tekmar Representative, including an inquiry from Purchaser (if not a tekmar Representative) or Purchaser's customers, regarding a potential warranty claim, tekmar's sole obligation shall be to provide the address and other contact information regarding the appropriate Representative.

WARNING: This product contains chemicals known to the State of California to cause cancer and birth defects or other reproductive harm. For more information: [www.watts.com/prop65](http://www.watts.com/prop65)



Product design, software and literature are Copyright ©2014 by tekmar Control Systems Ltd., A Watts Water Technologies Company. Head Office: 5100 Silver Star Road, Vernon, B.C. Canada V1B 3K4, 250-545-7749, Fax. 250-545-0650 Web Site: [www.tekmarControls.com](http://www.tekmarControls.com)

