



Alternative
Energy

406_D

11/12

Replaces: 12/11

Introduction

The tN2 House Control 406 is designed to operate the equipment in a 2-pipe, single tank, hydronic heating and cooling system. It operates two heat pump stages (water-to-water or air-to-water) with a backup heat source (boiler or electric resistance). The heat pump provides either hot or chilled water to a storage tank loop and optional mixed temperature loop. For radiant heating, the water temperature is calculated using outdoor temperature reset. For radiant cooling, the chilled water temperature is maintained at an adjustable setpoint, or is adjusted using dew-point reset with a humidity sensor. A backup boiler can provide an outdoor reset water temperature as well as domestic hot water and setpoint water temperatures. The 406 operates 4 on-board heating and cooling zones and is expandable up to 52 zones total on the boiler, tank, and mix water temperatures.

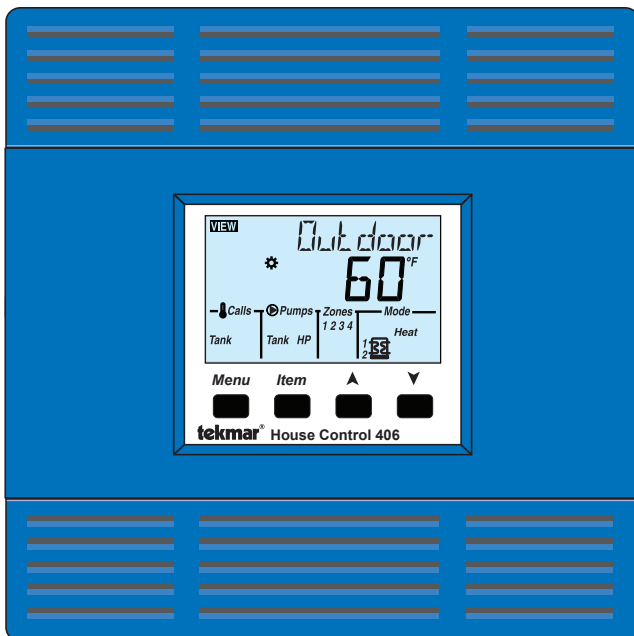

Features

- One or two-stage heat pump control
- Equal runtime rotation for two heat pumps
- On/off or modulating boiler control
- Tank, mix and boiler outdoor reset temperatures
- Domestic hot water operation
- Setpoint operation
- Mixing with variable speed pump
- For use with tekmarNet®2 Thermostats
- Four 24 V (ac) built in powered zone valve outputs
- Expand to 24 zones on two water temperatures using tekmarNet®4 expansion ports
- CSA C US Certified for use in USA and Canada

Benefits

- Energy efficiency through Outdoor Temperature Reset with Indoor Temperature Feedback
- Indoor Temperature Feedback minimizes the water temperature (increasing energy savings), and the efficiency of your mechanical equipment through integrated tekmarNet® Thermostats
- Zone Synchronization reduces equipment cycling
- Auto Differential - Reduces boiler cycling
- Compact enclosure for flexible installation
- Simple zone expansion using Wiring Centers

Note

- For hydronic cooling with a fancoil, use tekmarNet®2 Thermostat 530 or tekmarNet®4 Thermostat 540 with a date code of **December 2011** or newer.
- For floor cooling, use tekmarNet®2 Thermostats 527, 528, 529, 530 or tekmarNet®4 Thermostats 537, 538, and 540 with a date code of **December 2011** or newer.

Table of Contents

Installation	2	Monitor Menu	29
Preparation	2	Toolbox Menu	31
Physical Dimensions	3	Sequence of Operation	32
Installation Location.....	3	tekmarNet® System	32
Rough-In Wiring.....	3	System Setup	32
Sizing the Transformer	4	Heat Cool Operation.....	34
Control Wiring.....	4	Hydronic Operation	35
Sensor Wiring	7	Heat Pump Operation.....	36
Testing the Sensor Wiring	8	DHW Operation	37
Testing the Control Wiring	9	Boiler Operation	39
Max Heat	10	Setpoint Operation	41
Applications.....	11	Mixing Operation	42
User Interface.....	21	Pump Operation	42
Display	21	Troubleshooting.....	43
Symbols.....	21	Error Messages	43
Navigating The Display	21	Frequently Asked Questions	46
Access Levels and Thermostat Lock	22	Job Record	47
Programming and Settings.....	22	Technical Data.....	48
View Menu	22	Limited Warranty and Product Return Procedure.....	48
Adjust Menu	24		

Getting Started

Congratulations on the purchase of your new tekmarNet® House Control!

This manual covers the complete installation, programming and sequence of operation for this control. You will also find instruction on testing, commissioning, and troubleshooting the control and system that it operates.

Installation

Caution

Improper installation and operation of this control could result in damage to the equipment and possibly even personal injury or death. It is your responsibility to ensure that this control is safely installed according to all applicable codes and standards. This electronic control is not intended for use as a primary limit control. Other controls that are intended and certified as

safety limits must be placed into the control circuit. Do not attempt to service the control. Refer to qualified personnel for servicing. There are no user serviceable parts. Attempting to do so voids warranty and could result in damage to the equipment and possibly even personal injury or death.

Radio Frequency Interference

The installer must ensure that this control and its wiring are isolated and/or shielded from strong sources of electromagnetic noise. Conversely, this Class B digital apparatus complies with Part 15 of the FCC Rules and meets all requirements of the Canadian Interference-Causing Equipment Regulations. However, if this control does cause harmful interference to radio or television reception, which is determined by turning

the control off and on, the user is encouraged to try to correct the interference by re-orientating or relocating the receiving antenna, relocating the receiver with respect to this control, and/or connecting the control to a different circuit from that to which the receiver is connected.

Cet appareil numérique de la classe B respecte toutes les exigences du Règlement sur le matériel brouilleur du Canada.

Preparation

Tools Required

- tekmar or jeweller screwdriver
- Phillips head screwdriver
- Needle-nose Pliers
- Wire Stripper

Materials Required

- (2) #10 x 1" Wood Screws
- (5) Wire Nuts
- 18 AWG LVT Solid Wire (Low Voltage Connections)
- 14 AWG Solid Wire (Line Voltage Connections)
- tekmar 009K (24 V (ac) transformer with 4" x 4" junction box)
- 4" x 4" Extension Ring for Electrical Junction Box
- Cable or Conduit Connectors

Power Required

- 115 V (ac), 1-phase, 15 A service from circuit breaker panel (potentially up to two circuits)
- Power disconnect (optional)

Physical Dimensions

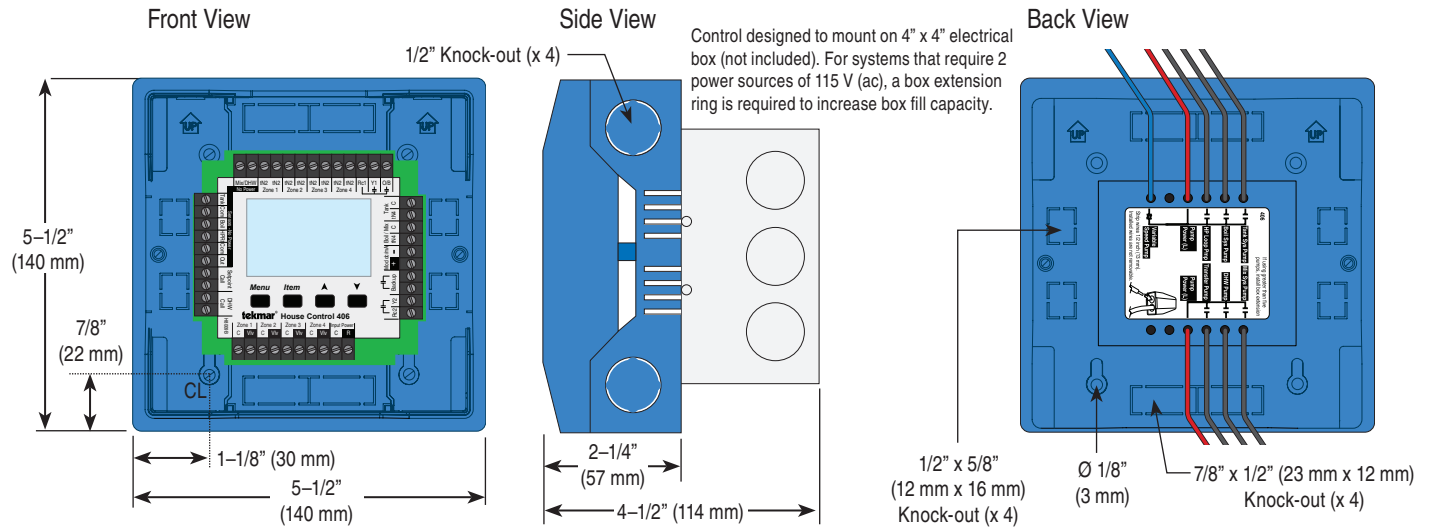

Installation Location

- When choosing the location for the control, consider the following:
- Keep dry. Avoid potential leakage onto the control.
RH ≤ 90% to 104°F (40°C).
Non-condensing environment.
- Do not expose to operating temperatures beyond 32-104°F (0-40°C)
- Provide adequate ventilation.
- Keep away from equipment, appliances or other sources of electrical interference.
- Locate the control near pumps and/or zone valves if possible.
- Provide easy access for wiring, viewing and adjusting the control.
- Mount approximately 5 ft. (1.5 m) off the finished floor.
- Install the electrical junction box to a wall using #10 x 1" wood screws. Wall anchors are recommended when mounting to sheet rock wallboard or masonry.
- Install the extension ring onto the electrical junction box. Total box volume must be 38 cubic inches (623 cm³) or greater to comply with National Electrical Code (NEC) or Canadian Electrical Code (CEC).

Rough-In Wiring

Line Voltage Wiring

The control operates a number of pumps through wiring on the back of the control. The control must be mounted to a 4" x 4" electrical junction box so that these electrical connections are safely contained.

For ease of service, the circuit breaker or power disconnect should be located in reasonably close proximity to the equipment.

All line voltage wire connections are recommended to be pulled inside a flexible or solid conduit. Always follow proper wiring practices, building and electrical codes for your jurisdiction.

Each cable must be pulled from the equipment to the electrical junction box. It is recommended to label each cable for easy identification. All line voltage wires should be stripped to a length of 1/2" (13 mm).

Low Voltage Wiring

Each cable must be pulled from the equipment to the control's plastic enclosure. All low voltage wiring connections enter the enclosure through conduit knockouts on the sides, or through the square knockouts on the rear. It is recommended to label

Pull a three conductor 14 AWG cable for the following equipment:

- Circuit Breaker or Power Disconnect
- Variable Speed Pump (if applicable)
- HP Loop Pump
- Boiler System Pump (if applicable)
- Tank System Pump (if applicable)
- Mix System Pump (if applicable)
- DHW Pump (if applicable)
- Transfer (Xfr) Pump (if applicable)

each cable for easy identification. All low voltage wires are to be stripped to a length of 3/8" (9 mm) to ensure proper connection to the control.

Pull two conductor 18 AWG LVT cable, up to 500 feet (150 m) for the following equipment:

- tekmarNet®2 Thermostats
- Heat Pump Compressor Stage 1
- Heat Pump Compressor Stage 2 (if applicable)
- Heat Pump Reversing Valve (O or B)
- Modulating Boiler 0-10 V (dc) or 4-20 mA (if applicable)
- On/Off Boiler or Backup Heat Source (if applicable)

- Outdoor Temperature Sensor
- HP Return Temperature Sensor
- Tank Supply Temperature Sensor
- Boiler Supply Temperature Sensor (if applicable)
- Mix Supply Temperature Sensor (if applicable)
- DHW Tank Temperature Sensor (if applicable)
- DHW Tank Aquastat (if applicable)
- Setpoint Device (if applicable)

Sizing the Transformer

The control requires an external transformer. A tekmar Transformer 009 (or 009K which includes a 4"x 4" electrical box) can supply up to 40 VA, and includes an in-line fuse to protect the transformer and control.

In order to correctly size the external transformer, all loads connected to the control must be taken into account.

When adding up the loads, consider the following:

- tekmarNet®2 Thermostats draw approximately 2 VA each.
- Each zone valve must be sized for peak load. This can be

obtained by multiplying the peak current draw (in Amps) by 24 V (ac).

- If using a Floating Action mixing valve, add the VA draw for the actuating motor. A tekmar Actuating Motor 741 draws 1.5 VA during normal operation.

The total power capacity of the power supply should be larger than the total load of all the devices connected to the control. This total load must not exceed 100 VA. Multiple tekmar Transformer 009's can be wired together to increase total VA capacity.

This chart is provided to simplify transformer sizing:

Zone	1	2	3	4	Control Load (VA)	Transformer must exceed: _____ VA
Thermostat Load						
Zone Valve Load						
Total Zone Load	_____ +	_____ +	_____ +	_____ +		

Control Wiring

Line Voltage Wiring

CAUTION: TURN ALL POWER OFF BEFORE PERFORMING ANY WIRING.

Ensure Junction Box Extension Ring is Installed

- An extension ring must be installed on the 4" x 4" junction box when 6 or more powered outputs for the pumps are used on the rear of the control.

Ground the Pumps

- Connect the pump grounds to the power supply ground as shown in Figure 1. The ground wire must also be grounded to the electrical box.

Wire the Pump Neutrals

- If the combined pump power load is less than 12 A, then a only a single 15 A circuit is required.
- If the combined pump power load exceeds 12 A, then two separate 15 A circuits are required.
- Each power circuit requires it's own neutral wire.
- Connect the Neutral (N) wires from each pump and wire to

the 115 V (ac) Neutral (N) wire. If the transformer has been mounted to this electrical box, connect its neutral wire with this group. This is shown in Figure 2 and Figure 3.

Wire the Pump Power (L)

- If the combined pump power load is less than 12 A, then a only a single 15 A circuit is required.
- If the combined pump power load exceeds 12 A, then two separate 15 A circuits are required.
- Connect the 115 V (ac) line voltage (L) wire to the red Pump Power (L) wire on the back of the House Control and to the 115 V (ac) side of the transformer. Use a wire nut or approved connector. See Figure 4.

Wire the Pumps

- Wire each remaining line voltage pump wire into the push-in wire connector of the corresponding pump lead on the back of the House Control. This is shown in Figure 5 and 6.

Figure 1 - Connect Ground Wires

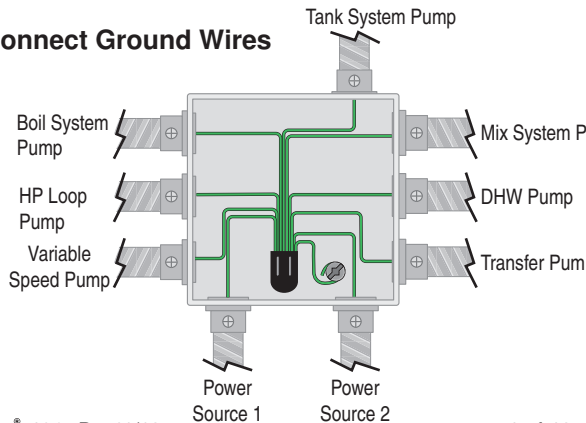

Figure 2 - Connect Neutral Wires for Power Source 1

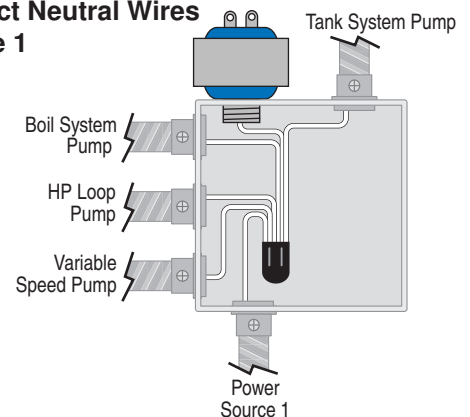

Figure 3 - Connect Neutral Wires for Power Source 2

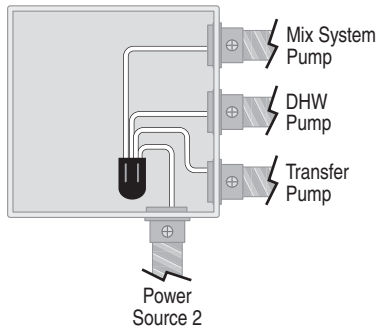

Figure 5 - System Pumps (Left)

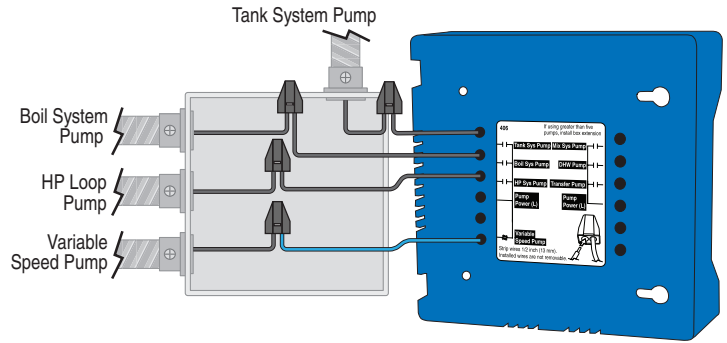

Figure 4 - Line Voltage

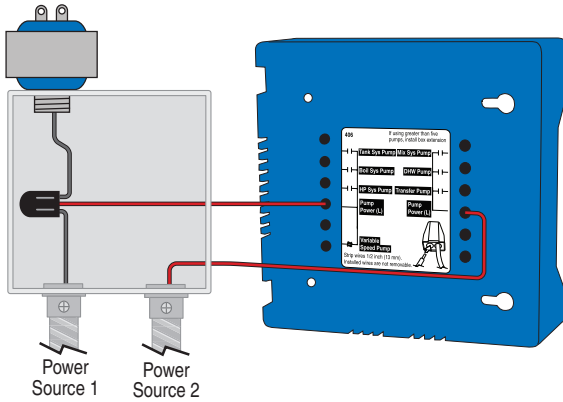
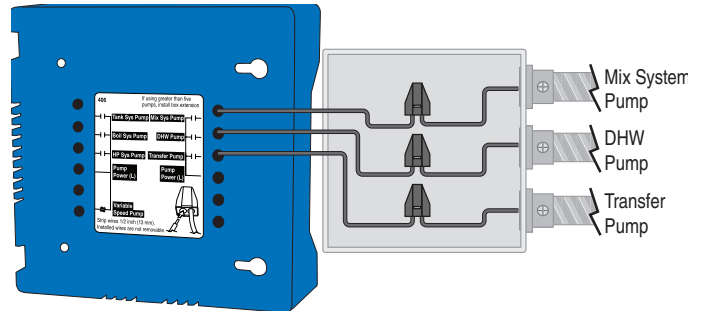
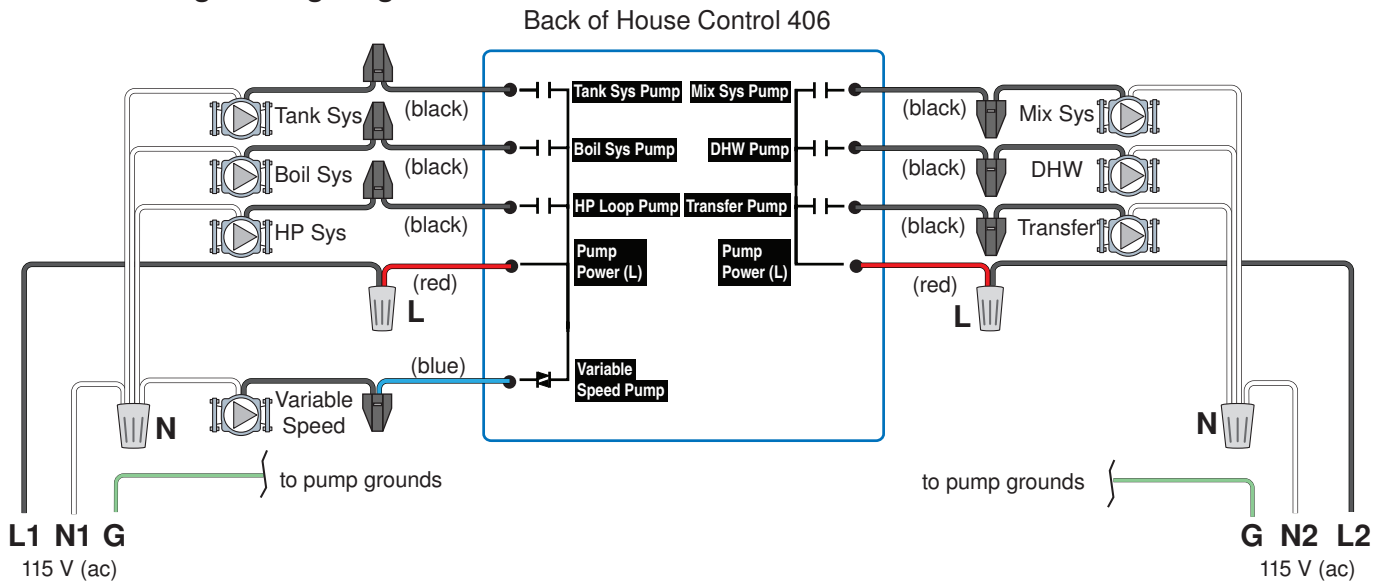

Figure 6 - System Pumps (Right)



Rear Line Voltage Wiring Diagram



Install The Enclosure

- Ensure that the pump wires are neatly tucked inside the electrical box.
- Using 2 of the 4 holes in the back of the enclosure, securely fasten it to the junction box extension ring with 2 #10 screws as shown in Figure 7.

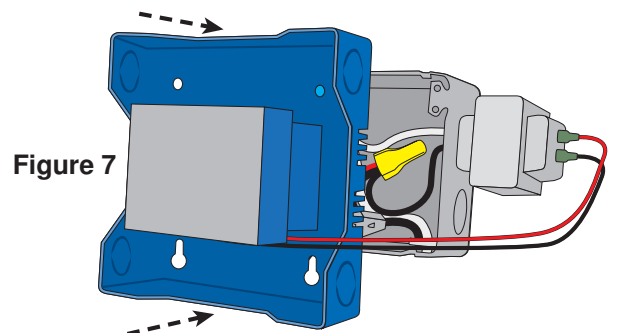

Front Low Voltage Wiring Diagram

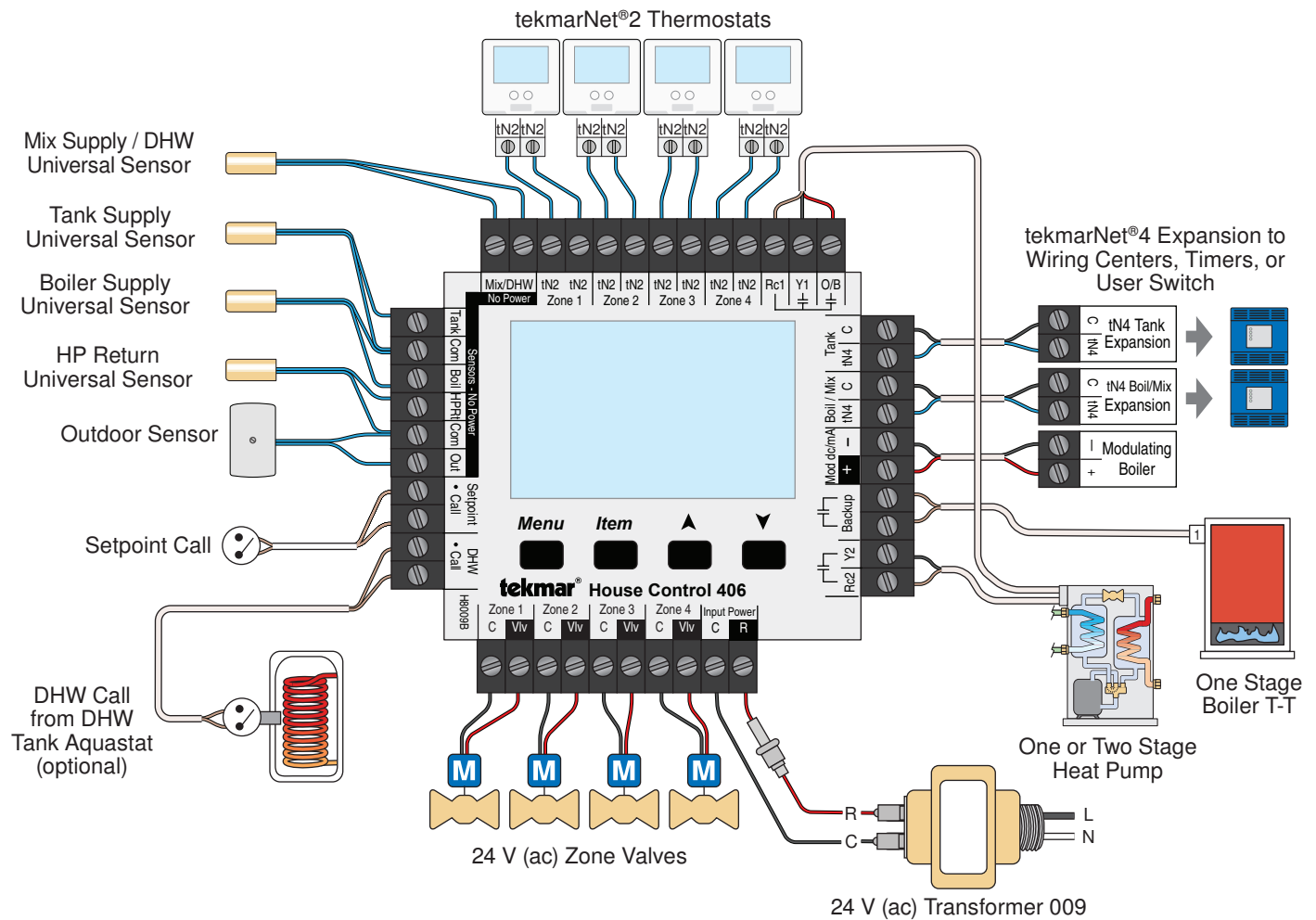

Low Voltage Wiring

External Power Supply

It is strongly recommended that a transformer with an in-line fuse be used in order to protect the transformer from high currents. The tekmar Transformer 009 includes a fuse.

- Connect the 24 V (ac) leads from the transformer to the C and R terminals marked "Input Power" on the 406.

tekmarNet®2 Thermostats (tN2)

The 406 is designed to operate with tekmarNet®2 Thermostats. They provide the heating and cooling control for each zone, and communicate with any other tekmarNet® device on the system.

- Connect the tN2 terminals from each thermostat to the corresponding tN2 terminals for each zone on the 406.

Zone Valves

- Wire the zone valves to the C and Vlv terminals on the 406.
- End switches on zone valves are not required when using the 406.

tN4 Expansion Terminals

The 406 uses the Expansion tN4 and C terminals to communicate with additional thermostats, setpoint controls, and other tekmarNet® devices. Connect to either the Tank or the Boil / Mix tN4 and C terminals on the 406.

Tank

To add additional Tank water temperature zones to the system, install a tekmarNet® Wiring Center.

- Connect the Tank terminals, tN4 and C, on the 406 to the corresponding tN4 and C Expansion terminals on the external Wiring Center.

Boil / Mix

To add additional Boil or Mix water temperature zones to the system, install a tekmarNet® Wiring Center.

- Connect the Boil/Mix terminals, tN4 and C, on the 406 to the corresponding tN4 and C Expansion terminals on the external Wiring Center.

Domestic Hot Water (DHW) or Setpoint Call

When the control receives a DHW Call or Setpoint Call for heat it will override Outdoor Reset and Indoor Feedback and operate the boiler to heat the DHW tank or the Setpoint equipment.

- To create a DHW call, wire a dry contact switch to the DHW call terminals.
- To create a Setpoint call, wire a dry contact switch to the Setpoint call terminals.

Wiring the Heat Pump

The 406 can operate a single heat pump with a two-stage compressor in heating or cooling mode.

- Connect the Rc1 and Y1 terminals on the 406 to the R and Y1 terminals on the heat pump.
- Connect the Rc2 and Y2 terminals on the 406 to the R and Y2 terminals on the heat pump.
- Connect the Rc1 and O/B terminal on the 406 to the R and O or B terminal on the heat pump.

Wiring the Auxiliary Backup

The 406 can operate an auxiliary backup other than a boiler.

- Use the Backup terminals on the 406 to switch on the auxiliary backup (ie electric element).

On/Off Boiler

- Connect the Backup terminals on the 406 to the T-T (or R-W) terminals on the boiler.

Modulating Boiler

- Wire the Mod (dc/mA) positive (+) and negative (-) terminals on the 406 to the input signal terminals on the boiler. Correct polarity of the wires is important.
- In some cases, the modulating boiler also requires contact closure on the T-T terminals to fire the boiler. If required, connect the Backup terminals on the 406 to the T-T (or R-W) terminals on the boiler.

Sensor Wiring

Mounting the Outdoor Sensor

Note: The temperature sensor (thermistor) is built into the sensor enclosure.

- Remove the screw and pull the front cover off the sensor enclosure.
- The outdoor sensor can either be mounted directly onto a wall or a 2" x 4" electrical box. When the outdoor sensor is wall mounted, the wiring should enter through the back or bottom of the enclosure. Do not mount the outdoor sensor with the conduit knockout facing upwards as rain could enter the enclosure and damage the sensor.

- In order to prevent heat transmitted through the wall from affecting the sensor reading, it may be necessary to install an insulating barrier behind the enclosure.
- The outdoor sensor should be mounted on a wall which best represents the heat load on the building (a northern wall for most buildings and a southern facing wall for buildings with large south facing glass areas). The outdoor sensor should not be exposed to heat sources such as ventilation or window openings.
- The outdoor sensor should be installed at an elevation above the ground that will prevent accidental damage or tampering.

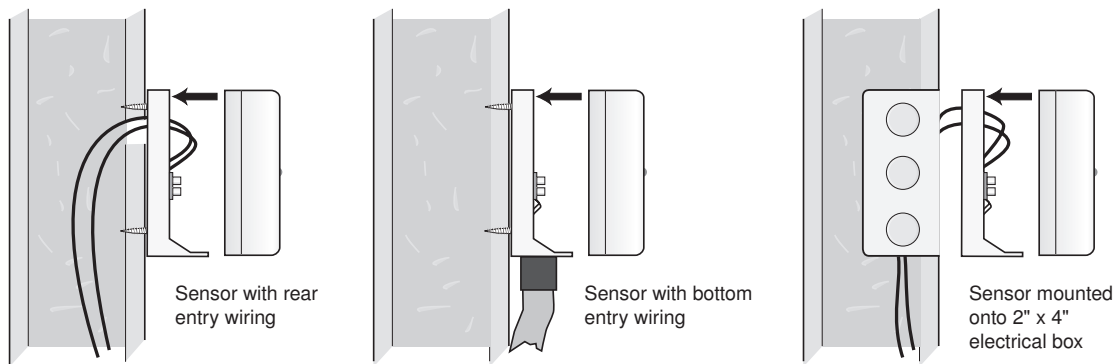

Wiring the Outdoor Sensor

- Connect 18 AWG or similar wire to the two terminals provided in the enclosure and run the wires from the outdoor sensor to the control. Do not run the wires parallel to telephone or power cables. If the sensor wires are located in an area with strong sources of electromagnetic interference (EMI), shielded cable or twisted pair should be used or the wires can be run in a grounded metal conduit. If using shielded cable, the shield wire should be connected to the Com or Com Sen terminal on the control and not to earth ground.
- Follow the sensor testing instructions in this brochure and connect the wires to the control.
- Replace the front cover of the sensor enclosure.

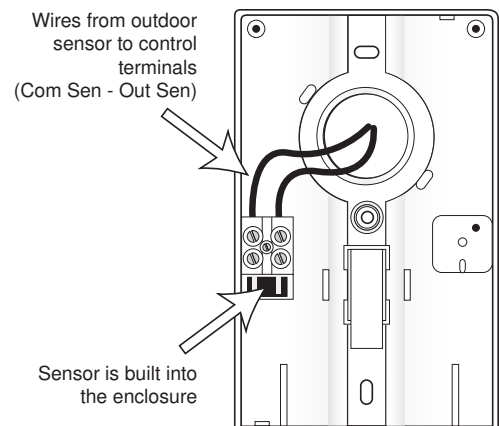

Mounting the Universal Sensor

Note: These sensors are designed to mount on a pipe or in a temperature immersion well.

The Universal Sensor should be placed downstream of a pump or after an elbow or similar fitting. This is especially important if large diameter pipes are used as the thermal stratification within the pipe can result in erroneous sensor readings. Proper sensor location requires that the fluid is thoroughly mixed within the pipe before it reaches the sensor.

Strapped to Pipe

The Universal Sensor can be strapped directly to the pipe using the cable tie provided. Insulation should be placed around the sensor to reduce the effect of air currents on the sensor measurement.

Immersion Well

If a Universal Sensor is mounted onto 1" (25 mm) diameter L type copper pipe, there is approximately an 8 second delay between a sudden change in water temperature and the time the sensor measures the temperature change. This delay increases considerably when mild steel (black iron) pipe is used. In general, it is recommended that a temperature well be used for steel pipe of diameter greater than 1-1/4" (32 mm). Temperature wells are also recommended when large diameter pipes are used and fluid stratification is present.

Conduit Connection

The Universal Sensor and Universal Sensor Enclosure 080 (sold separately) are specifically designed to mount onto a 3/8" (10 mm) ID temperature well that is supplied with an end groove. To install the well, plumb a 'T' into the pipe and fix the well into the 'T'. The 080 enclosure has a 7/8" (22 mm) back knockout that must be removed and fitted over the temperature well. The universal sensor is then inserted into the well and the retaining clip supplied with the enclosure is snapped onto the well end groove. If the well has a threaded end, the installer must supply a standard threaded conduit retaining ring. The two wires from the sensor are connected to the terminal block provided in the enclosure. The other side of the terminal block is used to connect wires from the control.

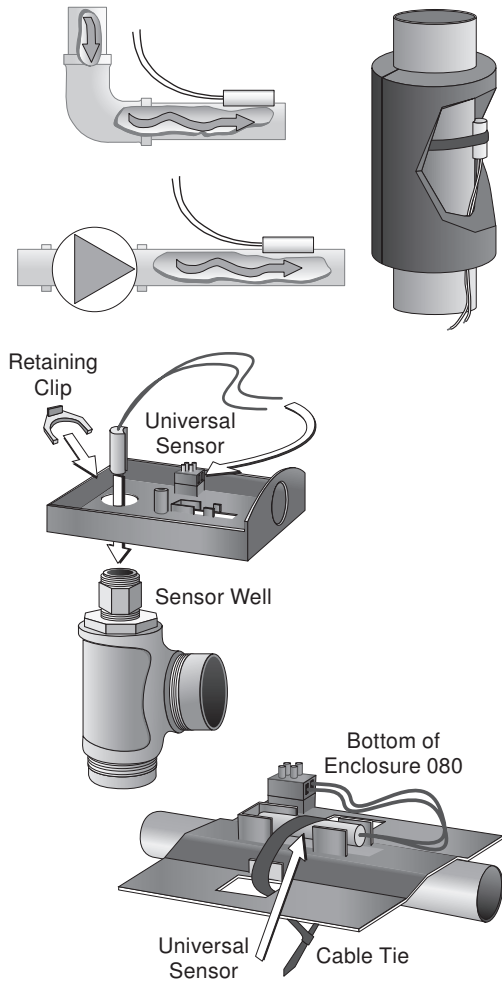

Testing the Sensor Wiring

A good quality test meter capable of measuring up to 5,000 k Ω (1 k Ω = 1000 Ω) is required to measure the sensor resistance. In addition to this, the actual temperature must be measured with either a good quality digital thermometer, or if a thermometer is not available, a second sensor can be placed alongside the one to be tested and the readings compared.

First measure the temperature using the thermometer and then measure the resistance of the sensor at the control. The wires from the sensor must not be connected to the control while the test is performed. Using the chart below, estimate

the temperature measured by the sensor. The sensor and thermometer readings should be close. If the test meter reads a very high resistance, there may be a broken wire, a poor wiring connection or a defective sensor. If the resistance is very low, the wiring may be shorted, there may be moisture in the sensor or the sensor may be defective. To test for a defective sensor, measure the resistance directly at the sensor location.

Do not apply voltage to a sensor at any time as damage to the sensor may result.

Temperature		Resistance	Temperature		Resistance	Temperature		Resistance	Temperature		Resistance
°F	°C	Ω	°F	°C	Ω	°F	°C	Ω	°F	°C	Ω
-50	-46	490,813	20	-7	46,218	90	32	7,334	160	71	1,689
-45	-43	405,710	25	-4	39,913	95	35	6,532	165	74	1,538
-40	-40	336,606	30	-1	34,558	100	38	5,828	170	77	1,403
-35	-37	280,279	35	2	29,996	105	41	5,210	175	79	1,281
-30	-34	234,196	40	4	26,099	110	43	4,665	180	82	1,172
-25	-32	196,358	45	7	22,763	115	46	4,184	185	85	1,073
-20	-29	165,180	50	10	19,900	120	49	3,760	190	88	983
-15	-26	139,403	55	13	17,436	125	52	3,383	195	91	903
-10	-23	118,018	60	16	15,311	130	54	3,050	200	93	829
-5	-21	100,221	65	18	13,474	135	57	2,754	205	96	763
0	-18	85,362	70	21	11,883	140	60	2,490	210	99	703
5	-15	72,918	75	24	10,501	145	63	2,255	215	102	648
10	-12	62,465	80	27	9,299	150	66	2,045	220	104	598
15	-9	53,658	85	29	8,250	155	68	1,857	225	107	553

Testing the Control Wiring

Testing the Power

If the control display does not turn on, check the Input Power wiring terminals using an electrical multimeter. The voltage should measure between 21.6 to 26.4 V (ac). If the voltage is below this range, measure the line voltage side of the transformer. The voltage should measure between 103.5 to 126.5 V (ac).

Testing the Thermostats

If the thermostat display turns on, this indicates that the thermostat is operating correctly and there are no electrical issues. In the event that the display is off, or the display is cycling on and off, follow this procedure.

1. Remove the tN2 wires from the thermostat.
2. Use an electrical meter to measure DC voltage between the tN2 terminals.

If the DC voltage is 0 V (dc) for 20 seconds, then there is an open or short circuit in the tN2 wires. If the DC voltage is 0 V (dc) for 10 seconds and then is 23 to 24 V (dc) for 5 seconds, this indicates the wiring is correct.

3. Connect the thermostat to the tN2 wires from a zone on a House Control, Wiring Center, or Zone Manager.
4. If the thermostat display is off, or is cycling on and off, move the thermostat to the next available zone on the House Control, Wiring Center, or Zone Manager.

If the thermostat display remains permanently on, there may be a fault with the previously tried zone on the House Control, Wiring Center, or Zone Manager.

If the thermostat display continues to be off, or is cycling on and off, there may be a fault on the thermostat.

If a fault is suspected, contact your tekmar sales representative for assistance.

User Test

The User Test is found in the Toolbox menu of the control. Press the Menu button to access the Toolbox Menu. Press the Item button to locate the User Test.

Start the test sequence by going to the User Test item and pressing the 'Up' arrow button.

Pause the test sequence by pressing the Item button. To advance to the next step, press the Item button again.

If the test sequence is paused for more than five minutes, the control exits the entire test routine and returns to normal operation.

To advance to a particular step, repeatedly press and release the Item button to display the appropriate device.

User Test Sequence

- Step 1 Zone 1 turns on for 10 seconds.
- Step 2 Zone 2 turns on for 10 seconds.
- Step 3 Zone 3 turns on for 10 seconds.
- Step 4 Zone 4 turns on for 10 seconds.
- Step 5 The Mix 1 device ramps up to 100% over 30 seconds or according to the motor speed setting.
- Step 6 The Mix 1 device ramps down to 0% over 30 seconds or according to the motor speed setting.
- Step 7 The mix system pump turns on for 10 seconds.
- Step 8 The tank system pump turns on for 10 seconds.
- Step 9 The O/B contacts are closed for 10 seconds.
- Step 10 The HP loop pump turns on for 10 seconds.

Step 11 The HP loop pump turns on and the Y1 contacts are closed for 10 seconds

Step 12 The HP loop pump turns on and the Y2 contacts are closed for 10 seconds if HP TYPE = ROT.

The HP loop pump turns on and the Y1 and Y2 contacts are closed for 10 seconds if HP TYPE = 2STG.

Step 13 The Backup contacts are closed for 10 seconds if BACKUP = AUX.

Step 14 The transfer pump turns on for 10 seconds if BACKUP = XFER.

Step 15 The variable speed pump turns on for 10 seconds if BACKUP = VAR.

Step 16 The DHW pump turns on for 10 seconds if WATERTEMP = T+B or T+MB and DHW Mode ≠ OFF.

Step 17 The boil system pump turns on for 10 seconds if WATERTEMP = T+B or T+MB.

Step 18 If WATERTEMP = T+B or T+MB The boil system pump turns on, and the tN2 zones, transfer pump, variable speed pump (20%), and tank pump turn on if necessary.

- If the Boil Type is 1 Stage, the backup relay is closed for 10 seconds and then opened.
- If Boiler Type is modulating 0-10 or 4-20, the backup relay is closed for 10 seconds and the modulating output operates at 50 % [5 V (dc) or 12 mA].

Step 19 Control returns to normal operation.

Testing the Zone Output

Activate the User Test sequence and pause at Step 1 by pressing the Item button once Zone 1 turns on. Using an electrical meter, measure the voltage between the zone valve and the common (C) terminals. The voltage should measure between 21.6 V (ac) and 26.4 V (ac). Repeat for Zones 2, 3, and 4.

Testing the Variable Speed Pump

Activate the User Test sequence and pause at Step 5 or Step 15 by pressing the Item button once the variable speed pump is operating at 100%. Using an electrical meter, measure the voltage between the variable speed pump and a neutral. The voltage should measure between 103.5 V (ac) and 126.5 V (ac).

Testing the Mix System Pump

Activate the User Test sequence and pause at Step 7 by pressing the Item button once the mix system pump turns on. Using an electrical meter, measure the voltage between the mix system pump and a neutral. The voltage should measure between 103.5 V (ac) and 126.5 V (ac).

Testing the Tank System Pump

Activate the User Test sequence and pause at Step 8 by pressing the Item button once the tank system pump turns on. Using an electrical meter, measure the voltage between the tank system pump and a neutral. The voltage should measure between 103.5 V (ac) and 126.5 V (ac).

Testing the O/B Contact

Activate the User Test sequence and pause at Step 9 by pressing the Item button once the O/B contact turns on. Using an electrical meter, measure for continuity between the O/B and Rc1 terminals.

Testing the HP Loop Pump

Activate the User Test sequence and pause at Step 10 by pressing the Item button once the HP Loop pump turns on. Using an electrical meter, measure the voltage between the HP Loop pump and a neutral. The voltage should measure between 103.5 V (ac) and 126.5 V (ac).

Testing the Heat Pump Stage 1 Contact

Activate the User Test sequence and pause at Step 11 by pressing the Item button once the Y1 contact turns on. Using an electrical meter, measure for continuity between the Y1 and Rc1 terminals.

Testing the Heat Pump Stage 2 Contact

Activate the User Test sequence and pause at Step 12 by pressing the Item button once the Y2 contact turns on. Using an electrical meter, measure for continuity between the Y2 and Rc2 terminals.

Testing the Backup Contact

Activate the User Test sequence and pause at Step 13 or Step 18 by pressing the Item button once the boiler stage 1 turns on. Using an electrical meter, measure for continuity over the Backup terminals.

Testing the Transfer Pump

Activate the User Test sequence and pause at Step 14 by pressing the Item button once the Transfer pump turns on. Using an electrical meter, measure the voltage between the Transfer pump and a neutral. The voltage should measure between 103.5 V (ac) and 126.5 V (ac).

Testing the DHW Pump

Activate the User Test sequence and pause at Step 16 by pressing the Item button once the DHW pump turns on. Using an electrical meter, measure the voltage between the DHW pump and a neutral. The voltage should measure between 103.5 V (ac) and 126.5 V (ac).

Testing the Boiler System Pump

Activate the User Test sequence and pause at Step 17 by pressing the Item button once the boiler system pump turns on. Using an electrical meter, measure the voltage between the boiler system pump and a neutral. The voltage should measure between 103.5 V (ac) and 126.5 V (ac).

Testing the Boiler Modulating Output

This test applies for modulating boilers only.

Active the User Test sequence and pause at Step 18 by pressing the Item button once the boiler stage 1 turns on. Using an electrical meter, measure for either a 5 V (dc) or 12 mA signal. The Boil Type setting selects whether the signal is V (dc) or mA.

Testing the DHW Call

Remove all wires from the DHW Call terminals. The control display should show no DHW Call. Reconnect wires. Then apply either a short circuit or 24 V (ac) over the DHW Call terminals. The control should now show a DHW Call.

Testing the Setpoint Call

Remove all wires from the Setpoint Call terminals. The control display should show no Setpoint Call. Reconnect wires. Then apply either a short circuit or 24 V (ac) over the Setpoint Call terminals. The control should now show a Setpoint Call.

Max Heat

The control has a function called Max Heat. In this mode, the control turns on and operates the system up to the maximum set temperatures as long as there is a call for heat. Use this mode to run the circulators during system start-up and commissioning, and purging air from the piping. This function is useful when drying sheet rock and paint in the building.

To enable Max Heat, enter the Toolbox Menu and find Max Heat. Use the up arrow to select 'On'.

- When a space heating call is present, the heat pump and backup will run to maintain the target at the Design temperature. (One can purge the system using this test and leave the heat pump and backup un-powered. This will prevent heat from entering the system during the purge.)

- When a DHW Call or Setpoint Call is present, the boiler will operate at the DHW exchange or Setpoint temperature settings.
- WWSD and DHW Priority are disabled during Max Heat mode.
- Cooling is disabled during Max Heat mode.
- When Max Heat is on the display will show 'Max Heat Test'.
- Max Heat will automatically turn off after 24 hours.

To cancel Max Heat, go to Max Heat in the Toolbox menu and use the down arrow to select 'Off'.

Applications

Mechanical

A406-1

Description: The House Control 406 operates a two stage air source heat pump in heating or cooling mode to supply an outdoor reset water temperature to 4 on board tank temperature zones. Additional zones can be added using the Tank tN4 and C Expansion terminals. Domestic Hot Water pre-heat is achieved by maintaining the DHW sensor S5 in the preheat storage tank at an adjustable temperature, 90°F (32°C) default, using the DHW pump P6. The heat pump will target a water temperature 20°F (11°C) higher than the preheat tank target at the return sensor S2, and is limited by the HP RETURN MAX setting in the Adjust Menu. An electric element in the system storage tank is switched on through an isolation relay with the backup relay on the 406 to provide backup heat to maintain the Tank Sensor S4 at its target temperature.

Tank zones can have fan-coils, air handling units, chilled beams, or chilled panels as their terminal units depending on the type of tekmarNet® thermostat selected.

Legend

P2	HP Loop Pump
P4	Tank System Pump
P6	DHW Pump
S1	Outdoor Sensor
S2	HP Return Sensor
S4	Tank Sensor
S5	DHW Sensor

Application Settings

WATER TEMP	T (tank)
BACKUP	AUX (auxiliary)
HP LOOP	INT (intermittent)
HP TYPE	2STG (2-stage)
DHW MODE	5 (DHW preheat)

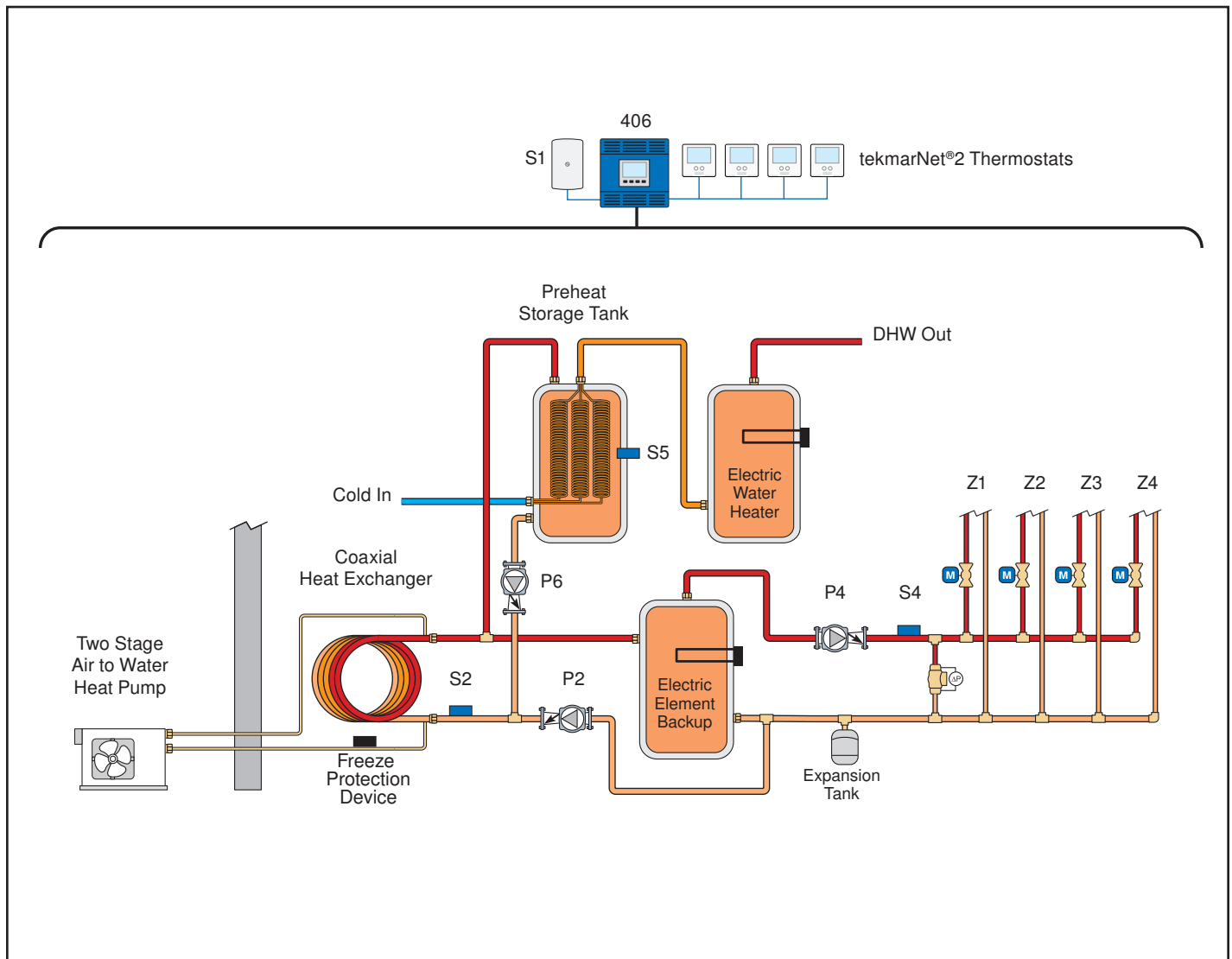

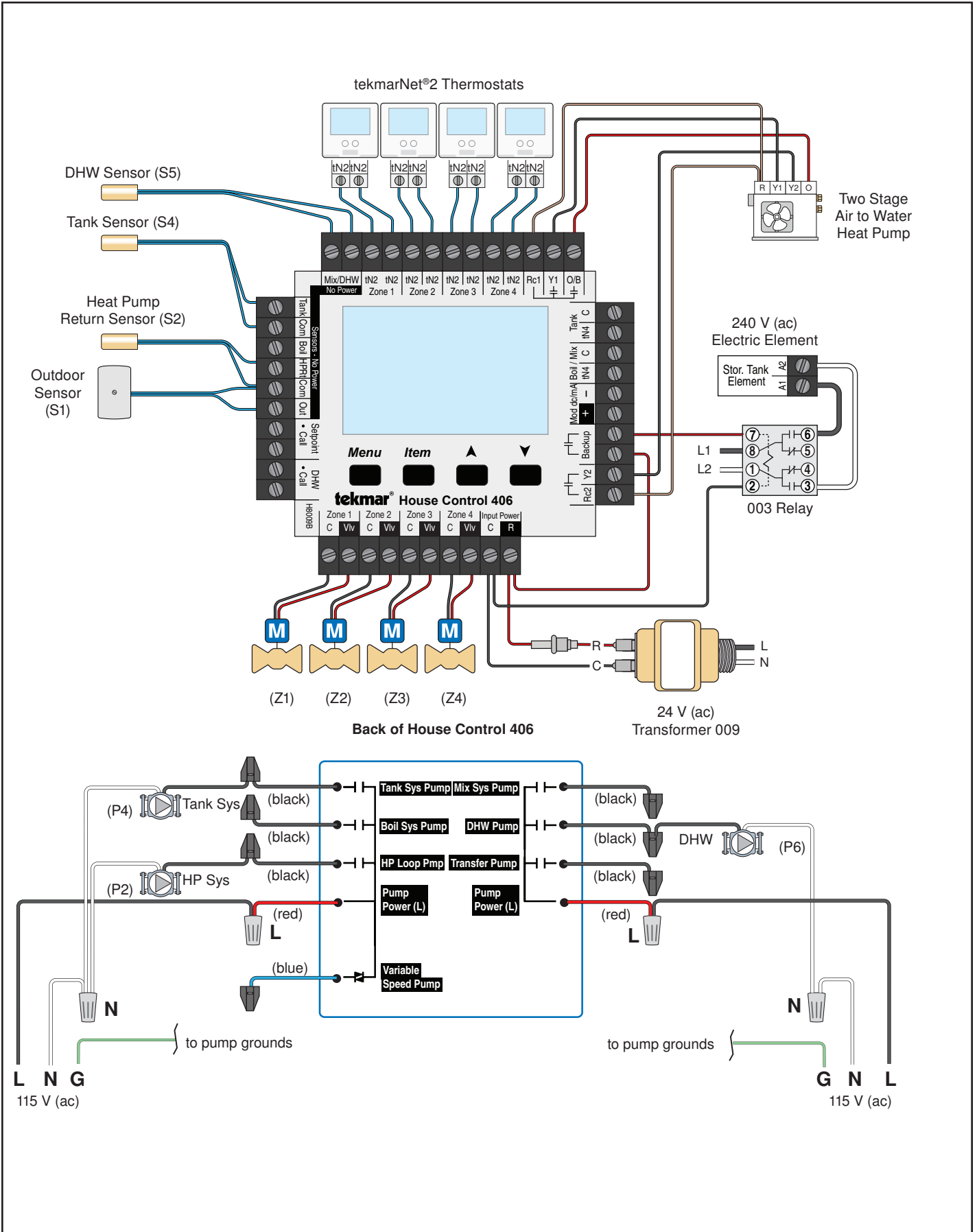

Description: The House Control 406 operates two air source heat pumps in heating or cooling mode to supply an outdoor reset water temperature to 4 on board mix temperature zones and 4 tank zones connected to the Tank expansion terminals with a Wiring Center 314. An electric boiler supplies backup heat using the Backup relay and the Transfer Pump P7.

By setting HP LOOP to ON, the HP Loop Pump P2 will operate whenever there is a call on the tank or mix bus, or when the transfer pump is on to ensure flow through the storage tank while heating or cooling.

Mixing is useful to separate the hot and cold water temperatures required for fancoils from the warm and cool temperatures required for radiant floor heating and cooling. The Variable Speed Pump P1 is able to mix the water temperature down for heating or mix the water temperature up above the dewpoint for floor cooling.

Legend

P1	Variable Speed Pump
P2	HP Loop Pump
P5	Mix System Pump
P7	Transfer Pump
S1	Outdoor Sensor
S2	HP Return Sensor
S3	Boiler Sensor
S4	Tank Sensor
S5	Mix Sensor

Application Settings

WATER TEMP	T+MB (tank + mix + boiler)
ZONES 1-4	MIX
BACKUP	XFER (transfer pump)
BOIL TYPE	1STG (1 stage)
HP LOOP	ON
HP TYPE	ROT (rotate)
DHW MODE	OFF

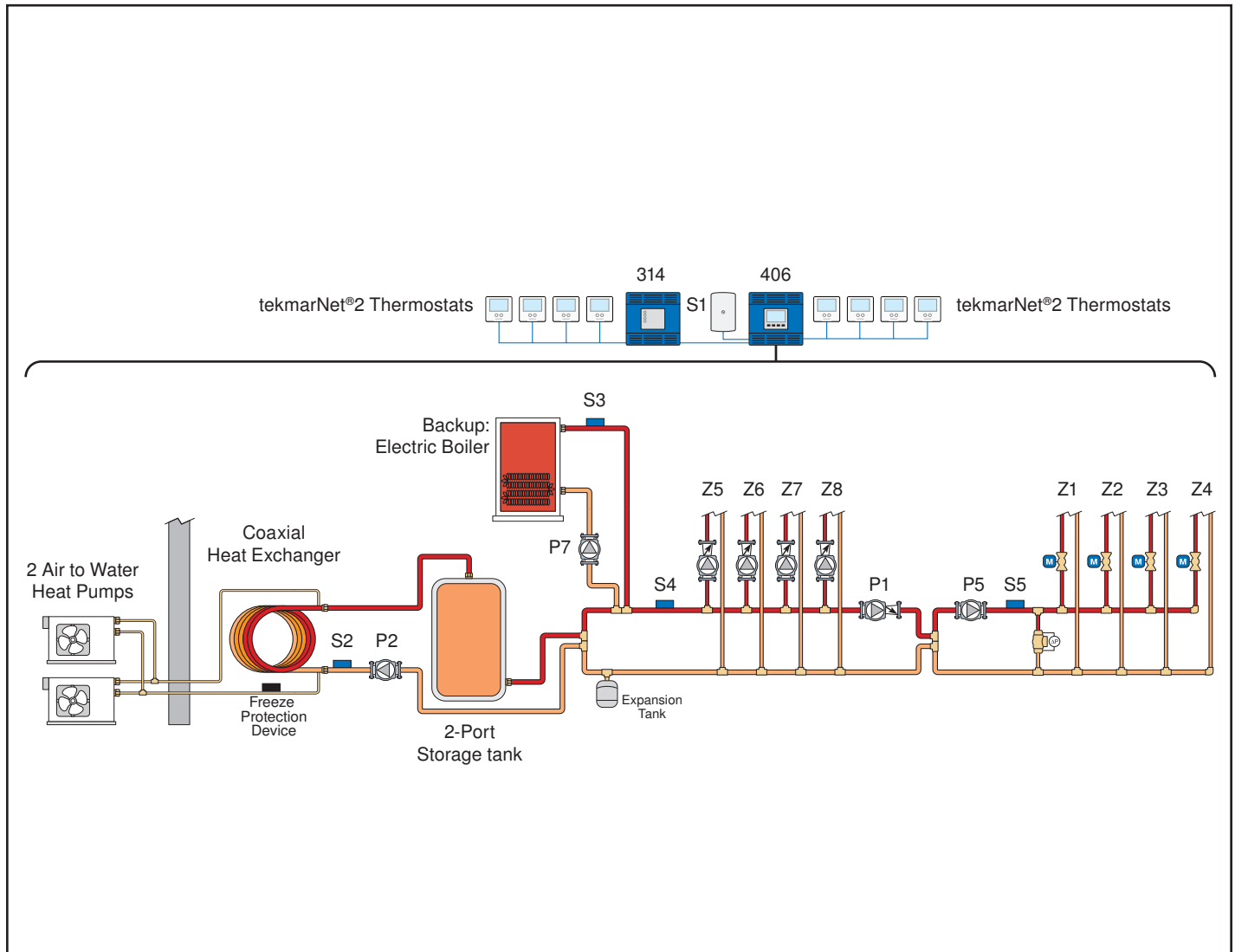

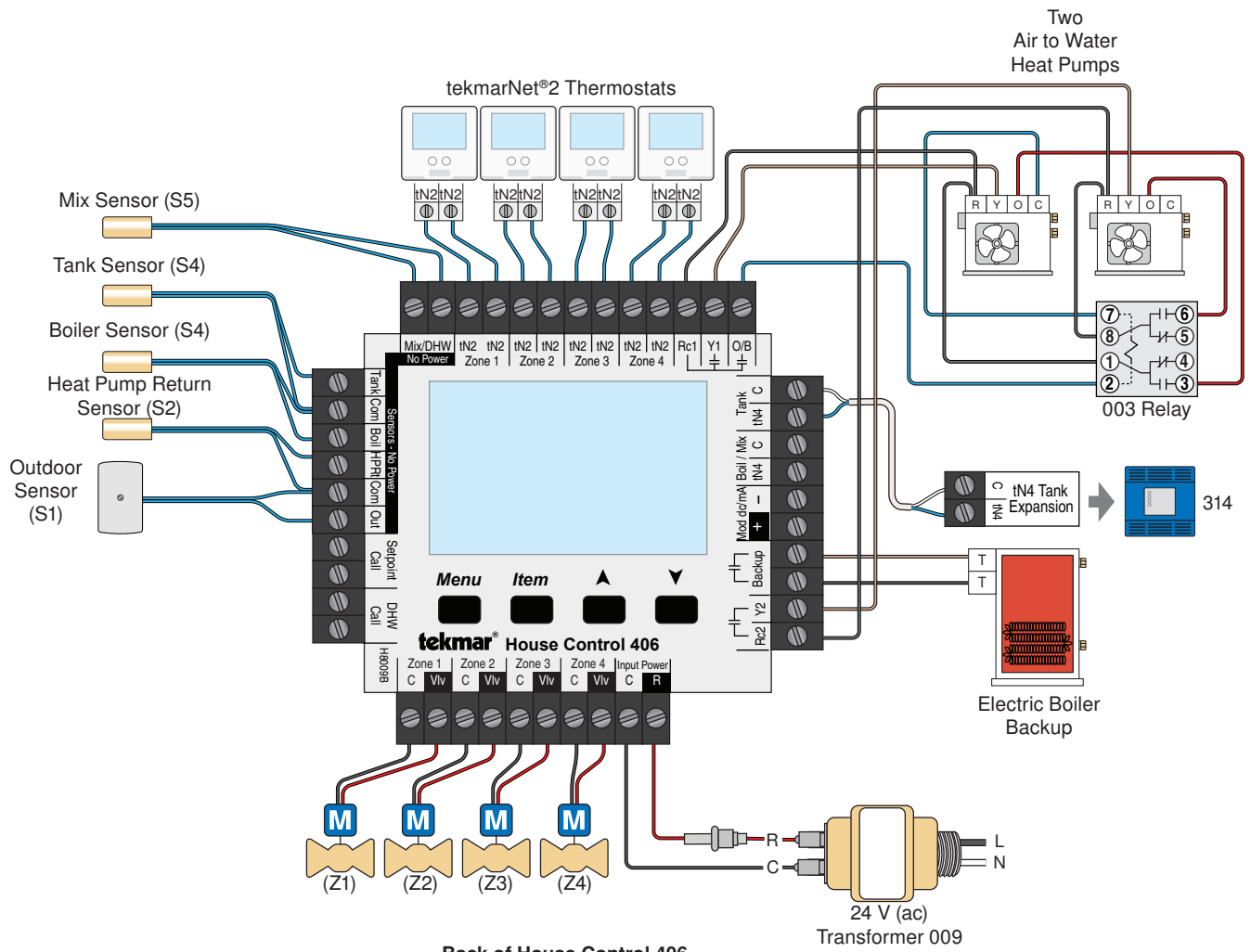

Back of House Control 406

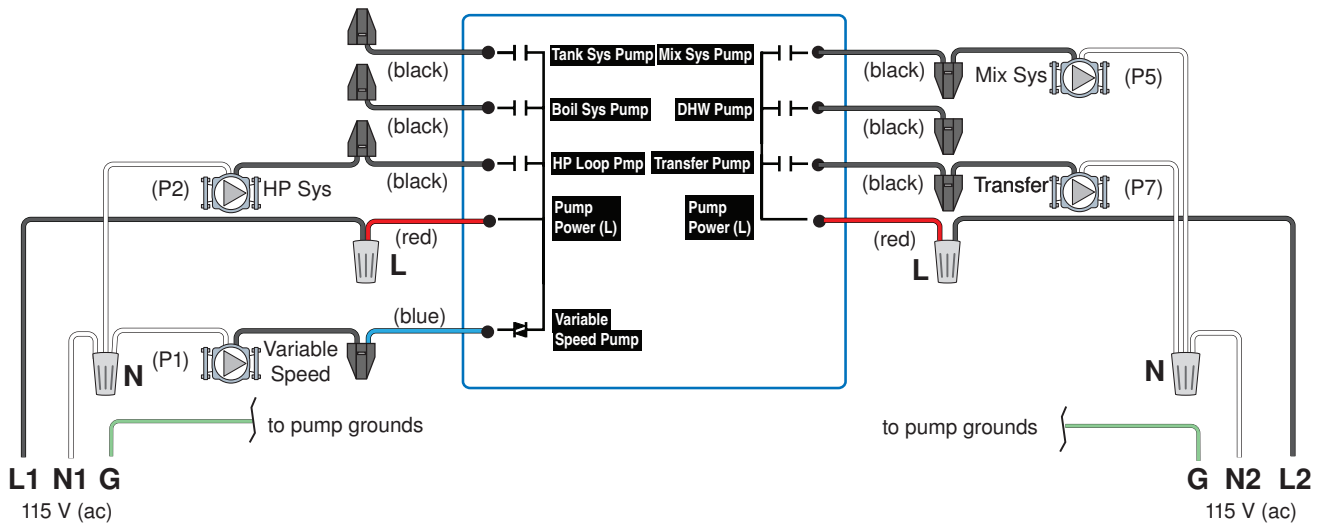

Description: The House Control 406 operates a water source heat pump in heating or cooling mode to supply an outdoor reset water temperature to 4 on board tank temperature zones. The 406 also operates a modulating condensing boiler to supply an outdoor reset water temperature to 4 boiler zones connected to the Boil expansion terminals with a Wiring Center 313. The boiler supplies backup heat to the tank loop using the transfer pump P7.

To allow the heat pump to operate for some amount of time before the transfer pump starts adding heat to the storage tank, use the backup delay setting in the adjust menu. This ensures the heat pump is being used to its full potential before backup is allowed. Placing the Transfer Pump P7 on the upstream side of the storage tank allows for hot water temperatures from the boiler loop to be buffered by the storage tank to prevent sending hot water out to the tank temperature zones.

Tank zones can have fan-coils, air handling units, chilled beams, or chilled panels as their terminal units depending on the type of tekmarNet® thermostat selected.

Legend

P2	HP Loop Pump
P3	Boiler System Pump
P4	Tank System Pump
P6	DHW Pump
P7	Transfer Pump
S1	Outdoor Sensor
S2	HP Return Sensor
S3	Boiler Sensor
S4	Tank Sensor
S5	DHW Sensor

Application Settings

WATER TEMP	T+B (tank + boiler)
ZONES 1-4	TANK
BACKUP	XFER (transfer pump)
BOIL TYPE	0-10
HP LOOP	INT
HP TYPE	1STG
DHW MODE	2

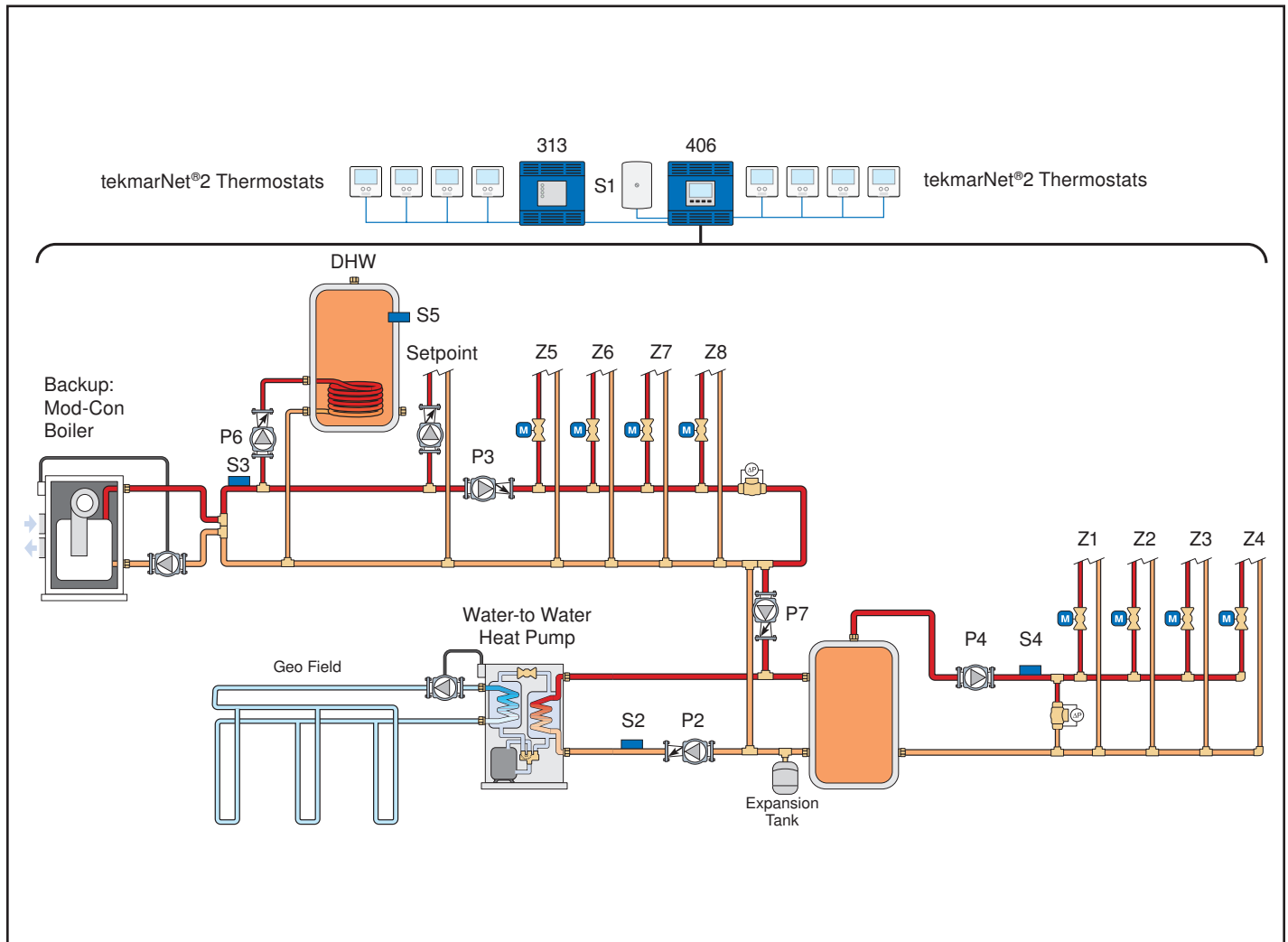

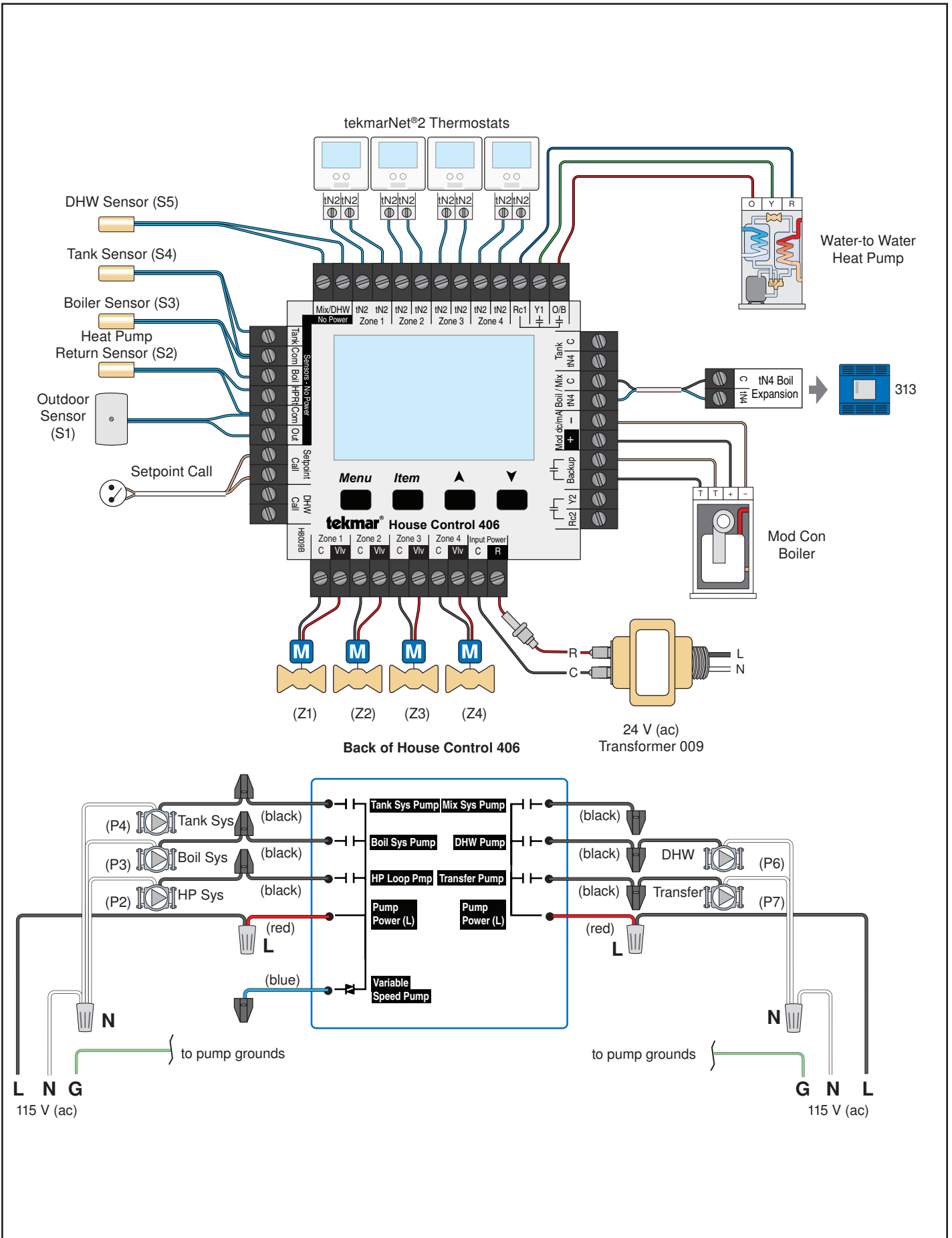

Description: The House Control 406 operates a two stage water source heat pump in heating or cooling mode to supply an outdoor reset water temperature to 4 on board tank temperature zones. The 406 also operates an on/off boiler to supply an outdoor reset water temperature to 4 boiler zones connected to the Boil expansion terminals with a Wiring Center 314. The boiler supplies backup heat to the tank loop using the variable speed pump P1.

To allow the heat pump to operate for some amount of time before the variable speed pump starts adding heat to the tank loop, use the backup delay setting in the adjust menu. This ensures the heat pump is being used to its full potential before backup is allowed. A non-condensing boiler may be used since P1 provides boiler return protection, preventing flue gas condensation.

Tank zones can have fan-coils, air handling units, chilled beams, or chilled panels as their terminal units depending on the type of tekmarNet thermostat selected.

Legend

P1	Variable Speed Pump
P2	HP Loop Pump
P3	Boiler System Pump
P4	Tank System Pump
P6	DHW Pump
S1	Outdoor Sensor
S2	HP Return Sensor
S3	Boiler Sensor
S4	Tank Sensor
S5	DHW Sensor

Application Settings

WATER TEMP	T+B (tank + boiler)
ZONES 1-4	TANK
BACKUP	VAR (variable speed pump)
BOIL TYPE	1STG (1 stage)
HP LOOP	INT
HP TYPE	2STG
DHW MODE	2

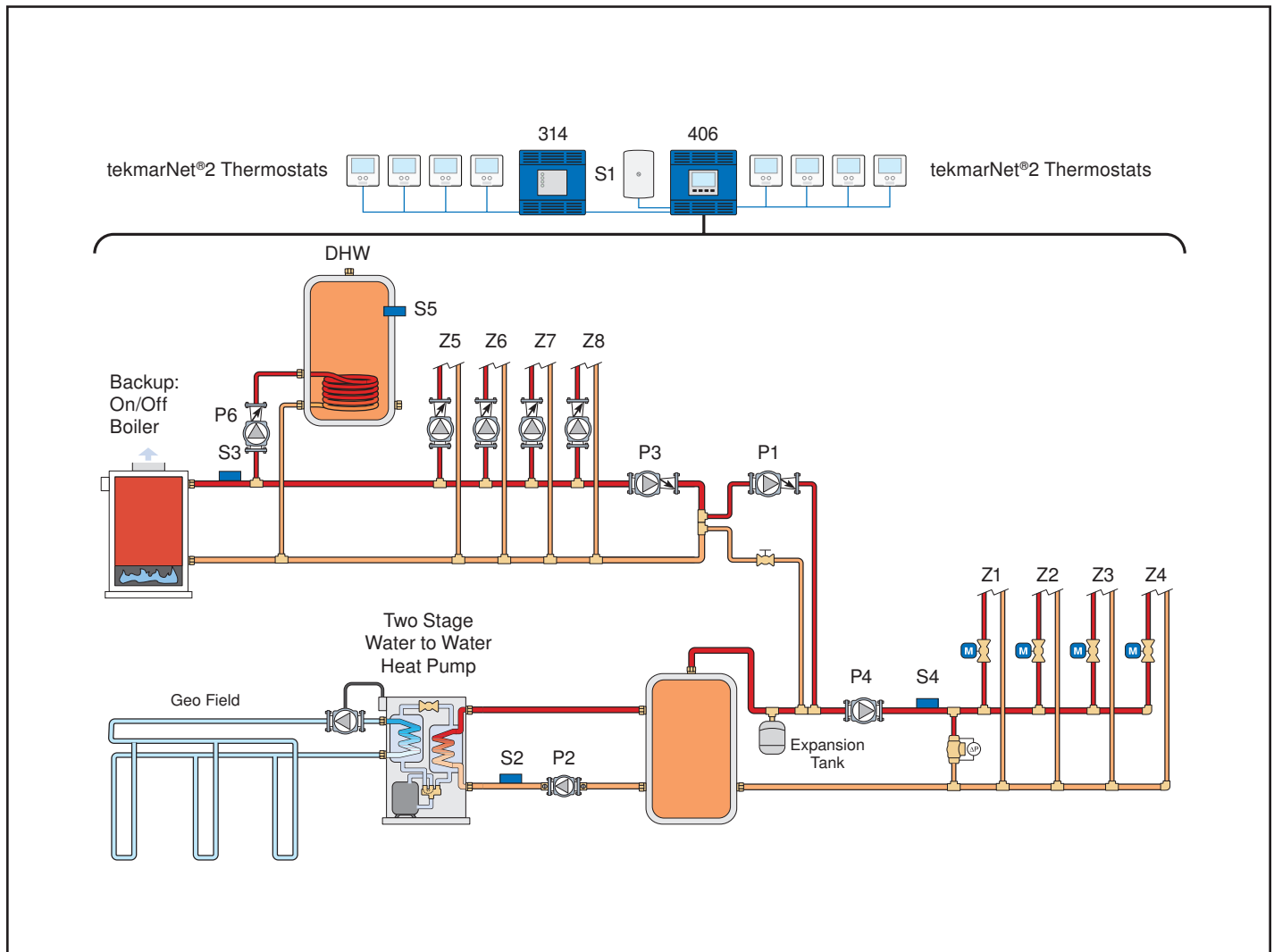

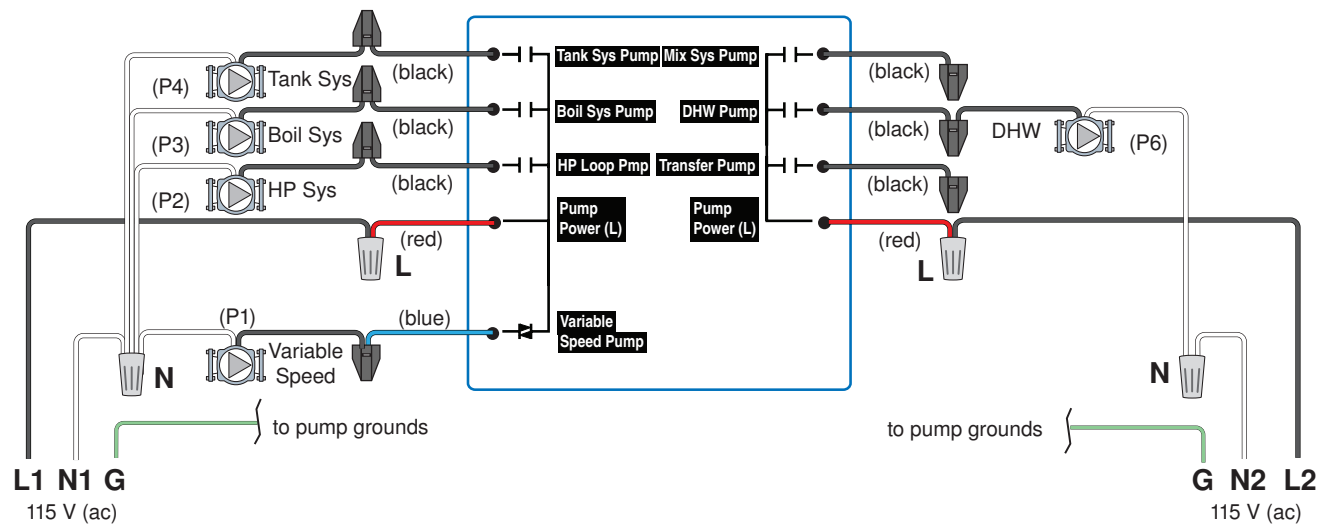
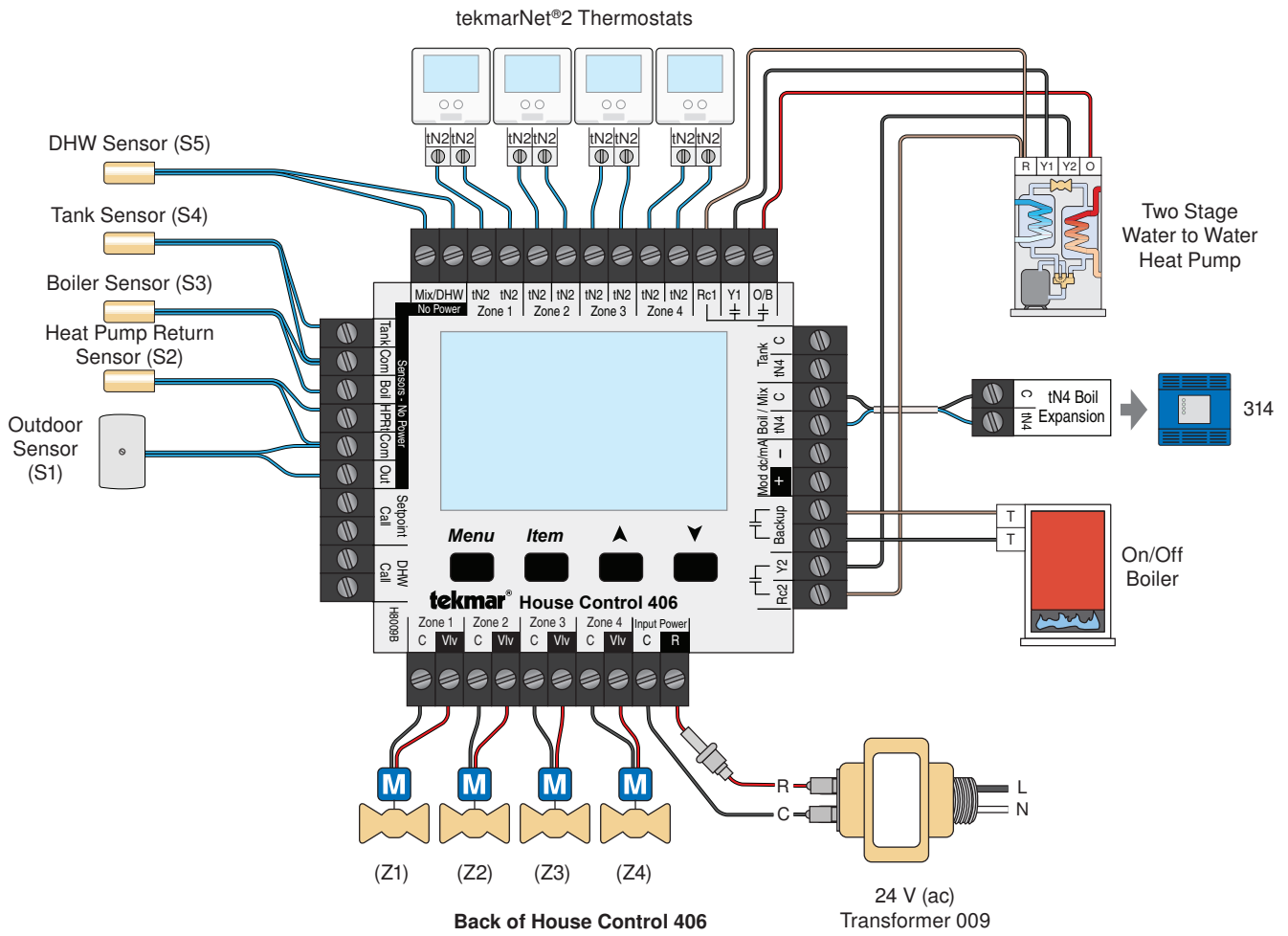

Description: The House Control 406 operates two water source heat pumps in heating or cooling mode to supply an outdoor reset water temperature to 4 on board mix temperature zones and 4 tank zones connected to the Tank expansion terminals with a Wiring Center 313. The 406 also operates a modulating condensing boiler to supply an outdoor reset water temperature to 4 boiler zones connected to the Boil expansion terminals with a Wiring Center 314. The boiler supplies backup heat to the tank loop using the transfer pump P7.

Mixing is useful to separate the hot and cold water temperatures required for fancoils from the warm and cool temperatures required for radiant floor heating and cooling. The Variable Speed Pump P1 is able to mix the water temperature down for heating or mix the water temperature up above the dewpoint for floor cooling.

IMPORTANT

- When a three water temperature application is selected (WATER TEMP = T+MB), either the Mix or Boiler bus is limited to the 4 tN2 on board thermostats, and the gateway controls 482 and 483 are unable to communicate to the four on-board tN2 zones on the House Control 406.

Legend

P1	Variable Speed Pump
P2	HP Loop Pump
P3	Boiler System Pump
P4	Tank System Pump
P5	Mix System Pump
P6	DHW Pump
P7	Transfer Pump
S1	Outdoor Sensor
S2	HP Return Sensor
S3	Boiler Sensor
S4	Tank Sensor

S5	Mix Sensor
A1	DHW Aquastat

Application Settings

WATER TEMP	T+MB (tank + mix + boiler)
ZONES 1-4	MIX
BACKUP	XFER (transfer pump)
BOIL TYPE	0-10
HP LOOP	INT
HP TYPE	ROT (rotate)
DHW MODE	4

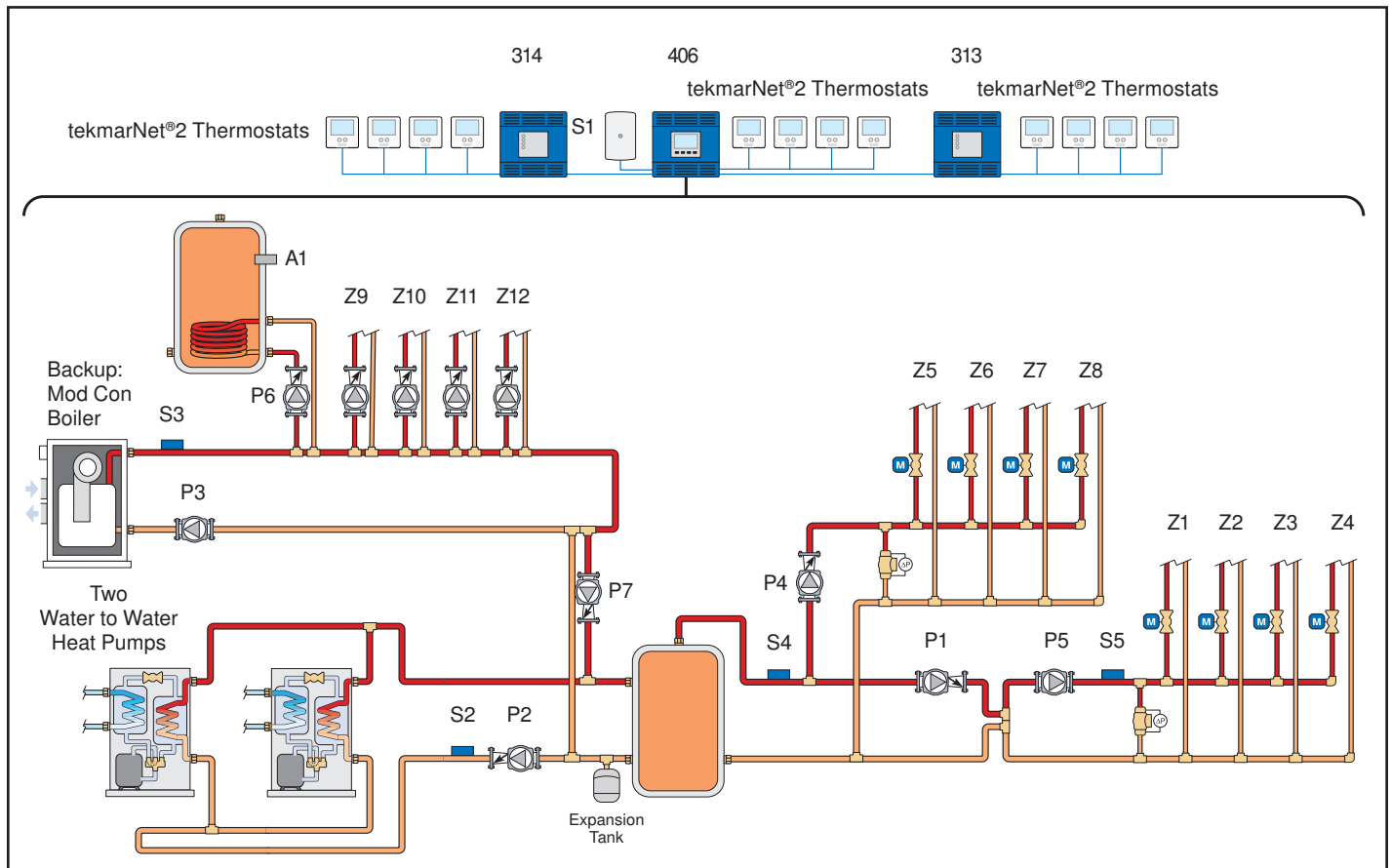

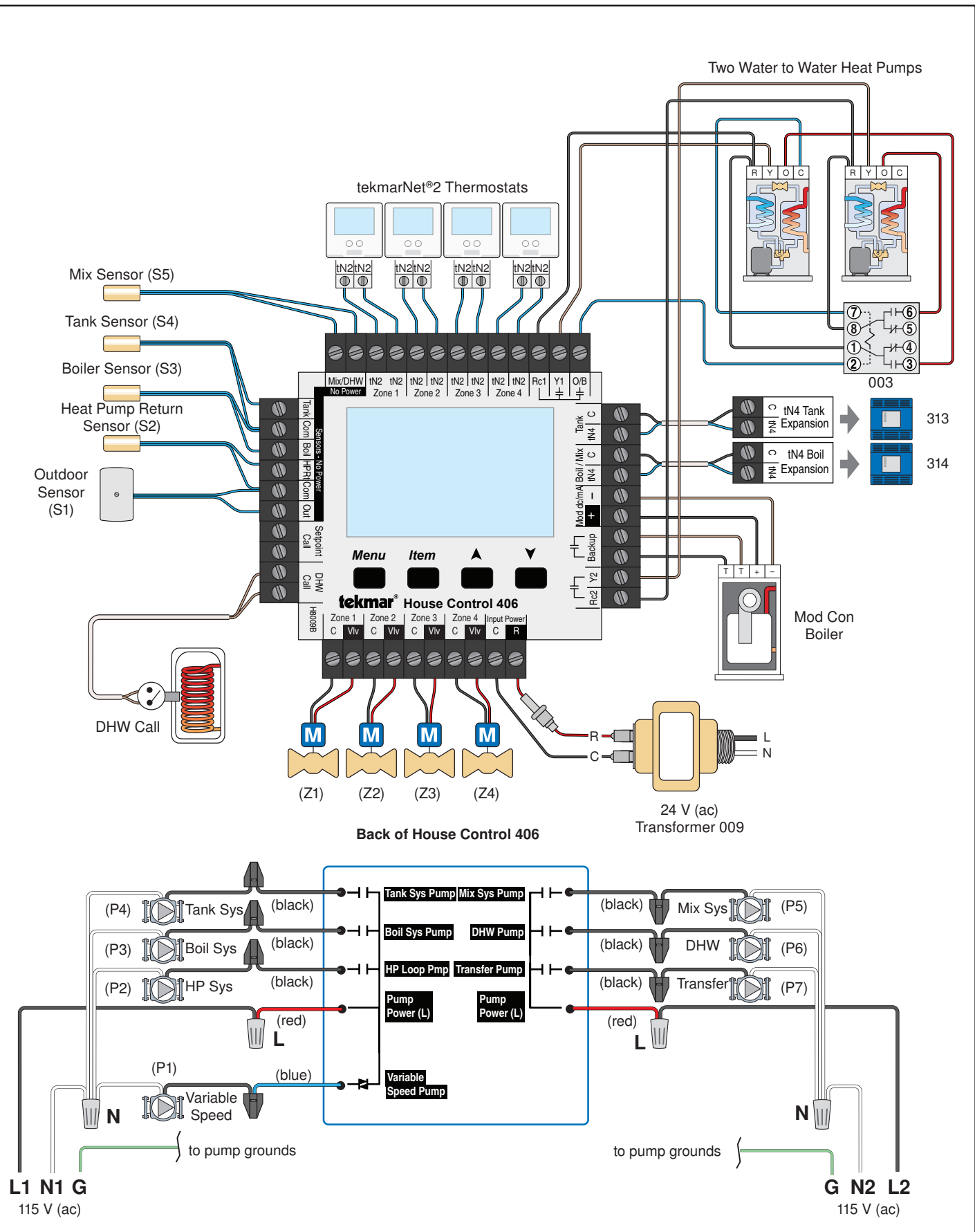

See page 40 for details on common modulating boiler settings.

User Interface

Display

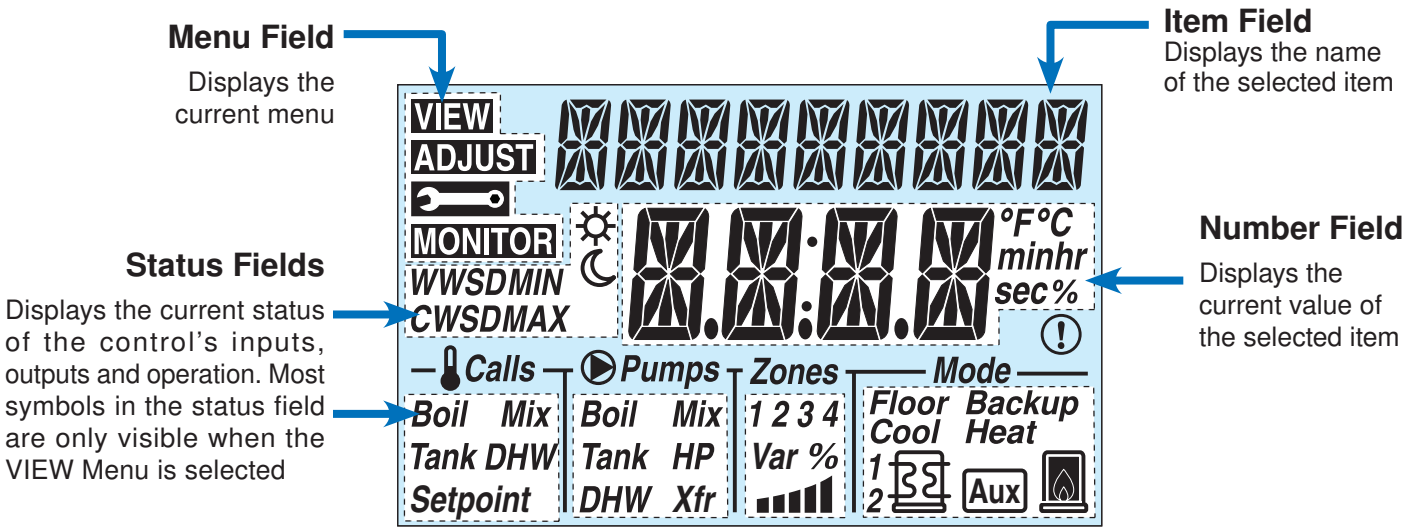

Symbols

	CALLS Displays any call for heat or cool the control is receiving.		HEAT PUMP Heat pump stage 1 or 2 is operating.
	PUMPS Displays any pump currently operating.		AUXILIARY An auxiliary backup heat source is currently operating using the Backup relay.
	ZONES Displays if an on-board zone is operating.		BOILER Indicates that the boiler is operating (flashing flame indicates boiler is igniting).
	VARIABLE SPEED PUMP OUTPUT Displays percent output of the variable speed pump.		FLOOR Radiant floor cooling is currently active.
	WWSD / CWSD The system is currently in Warm Weather Shut Down or Cold Weather Shut Down.		BACKUP Backup heat source is required to assist in heating the tank sensor to its target.
	MIN / MAX Heat pump is prevented from operating due to high or low return water temperature.		COOL / HEAT The heat pump is operating in either cool or heat mode.
	OCCUPIED Indicates that a User Switch or Timer has put the system into Occupied.		°F, °C, MINUTES, HOURS, SECONDS, % Units of measurement for current number.
	UNOCCUPIED Indicates that a User Switch or Timer has put the system into UnOccupied.		WARNING Displays if an error exists on the system.

Navigating The Display

The 406 uses a simple user interface to accomplish a variety of functions. The four buttons beneath the display are used

to change the menu, sort through Items, and adjust each setting as required.

Menu Button

The menus display in the Menu Field at the top left side of the LCD. Four menus are available: View, Adjust, Monitor and Toolbox (identified by the wrench symbol).

- The View menu allows the user to view the current status of various system parameters.
- The Adjust menu allows the installer to adjust settings to

ensure control operation matches requirements of the mechanical system.

- The Monitor menu keeps track of run times and other important data that is collected during system operation.
- The Toolbox menu is a source of system information and includes useful tools for commissioning and testing the system.

Item Button

Each menu contains a list of Items that can be viewed and, in some cases, adjusted. Press the item button to scroll through the list in each Menu.

- To view the next available item, press and release the Item button.
- To view the previous item, hold down the Item button, and press and release the Up button.

Up and Down Buttons

The Up and Down buttons are primarily used for adjusting settings.

To adjust a setting:

- Select the appropriate menu using the Menu button.

- Select the item using the Item button.
- Use the Up or Down button to make the adjustment.

Default Item

When navigating menus, the display reverts back to the default item (View Menu) after 60 seconds of button inactivity.

- To set the default item in the View menu, display the item for more than five seconds.

Access Levels and Thermostat Lock

The 406 is shipped pre-programmed with common settings. The 406 has an 'Installer' access level that allows full access to all settings and a 'User' access level that restricts the number of settings available. The 406 defaults to the 'User' access level after 12 hours of operation.

All thermostats are locked while the 406 is in the 'User' access level. Certain settings on the thermostat will be unavailable while the thermostat is locked.

To change to the 'Installer' access level and Unlock the thermostats:

- In the Toolbox menu, locate Access
- Adjust the access level to 'Installer' by pressing the up or down button. This will permit setting changes to the control.

Programming and Settings

The 406 settings can be found in the 'Adjust' menu. When changing the items value, the setting is saved to the control's memory once the Item button is pressed to advance to the next item, or after 60 seconds, the control times out and reverts back to the 'View' menu.

All settings are stored in permanent memory and will be kept correctly during any loss of power.

View Menu (1 of 3)

The View menu items display the current operating temperatures and status information of the system.

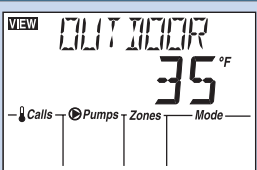
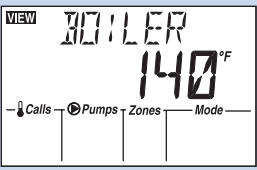
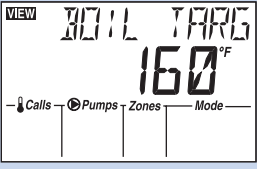
Item Field	Range	Description
	---, -76 to 149°F (-60 to 65°C)	OUTDOOR <i>SECTION D</i> Current outdoor air temperature as measured by the local or remote outdoor sensor. The outdoor air temperature is shared to all thermostats in the tekmarNet® system. "---" is displayed when no outdoor sensor is available.
	---, -22 to 266°F (-30 to 130°C)	BOILER <i>SECTION D</i> Current boiler supply water temperature as measured by the boiler sensor. The control operates the boiler so that the boiler supply is within the boiler differential of the boiler target. "---" is displayed when no boiler sensor is available. Note: This item is only available when a boiler water temperature is selected.
	---, 35 to 200°F (1.5 to 93.0°C)	BOILER TARGET <i>SECTION D</i> The boiler target is the temperature the control is currently trying to maintain at the boiler supply sensor. The boiler target is calculated based on the outdoor design, boiler design, and boiler minimum settings. "---" is displayed when no heat is required for boiler zones. Note: This item is only available when a boiler water temperature is selected.

View Menu (2 of 3)

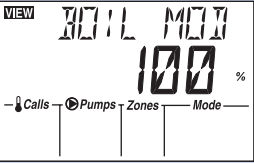
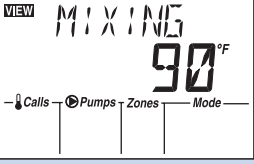
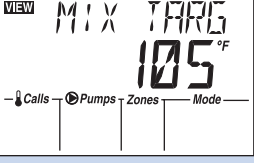
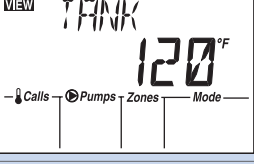
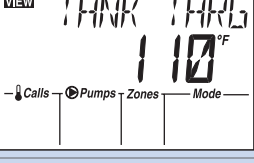
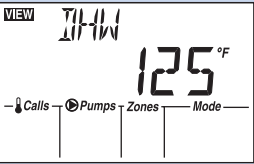
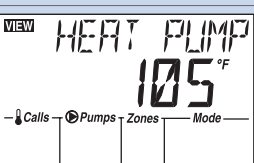
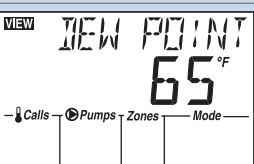
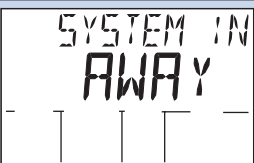
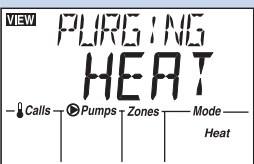

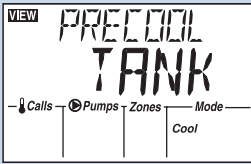
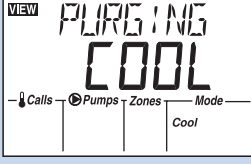
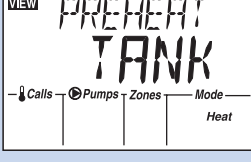

Item Field	Range	Description
	0-100%	<p>BOILER MODULATION <i>SECTION G</i></p> <p>Current percent modulation of the boiler's burner. The boiler modulation increases when the boiler supply is less than the boiler target. The boiler modulation decreases when the boiler supply is greater than the boiler target.</p> <p>Note: This item is only available when the BOIL TYPE setting is set to 0-10 or 4-20.</p>
	---, -22 to 266°F (-30 to 130°C)	<p>MIXING <i>SECTION D</i></p> <p>Current mix supply water temperature as measured by the mix sensor. The control operates the variable speed pump so that the mix supply is equal to the mix target. "---" is displayed when no mix sensor is available.</p> <p>Note: This item is only available when a mix water temperature is selected.</p>
	---, 35 to 200°F (1.5 to 93.0°C)	<p>MIX TARGET <i>SECTION D</i></p> <p>The temperature the control is currently trying to maintain at the mix sensor. The mix target is calculated based on the outdoor design and mix design settings. "---" is displayed when no heat is required for mix zones.</p> <p>Note: This item is only available when a mix water temperature is selected.</p>
	---, -22 to 266°F (-30 to 130°C)	<p>TANK <i>SECTION D</i></p> <p>Current tank supply water temperature as measured by the tank sensor. The control operates the heat pump and backup so that the tank supply is equal to the tank target. "---" is displayed when no tank sensor is available.</p>
	---, 35 to 200°F (1.5 to 93.0°C)	<p>TANK TARGET <i>SECTION D</i></p> <p>The temperature the control is currently trying to maintain at the tank sensor. The tank target is calculated based on the outdoor design and tank design settings. "---" is displayed when no heat is required for tank zones.</p>
	---, -22 to 266°F (-30 to 130°C)	<p>DOMESTIC HOT WATER <i>SECTION F</i></p> <p>Current Domestic Hot Water tank temperature as measured by the optional DHW sensor. If the DHW tank temperature falls 6°F (3.0°C) below the DHW Occ setting, a DHW call is created and the tank is heated. "---" is displayed when no DHW sensor is available.</p> <p>Note: This item is only available when a DHW sensor is installed and DHW Mode is set to 1 to 5.</p>
	---, -22 to 266°F (-30 to 130°C)	<p>HEAT PUMP <i>SECTION E</i></p> <p>Current heat pump return water temperature as measured by the HP Return sensor. The control operates the heat pump when the HP Return temperature is below the HP RETURN MAX setting in heating and above the HP RETURN MIN setting in cooling. "---" is displayed when no heat pump return sensor is available.</p>
	---, -35 to 273°F (-37 to 134°C)	<p>DEW POINT <i>SECTION C</i></p> <p>Highest dewpoint of all network humidity sensors. "---" is displayed when no dew point sensor is available.</p> <p>Note: This item is only available when a humidity sensor has been detected on the network and the access level is set to installer.</p>
		<p>SYSTEM IN AWAY</p> <p>The heating system is in the Away scene. The DHW tank will not be heated. Setpoint calls are still responded to.</p> <p>Use the User Switch to change scene out of Away.</p>
		<p>PURGING HEAT</p> <p>Heat is being purged from the storage tank and the heat pump is not allowed to come on. This may continue for up to 30 minutes and then precool will begin.</p>

View Menu (3 of 3)

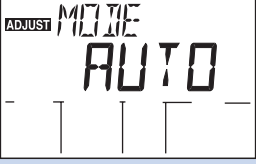

Item Field	Range	Description
		PRECOOL TANK The heat pump is cooling the storage tank while the zones remain off. This may continue for up to 30 minutes and then the zones are allowed to call for cooling.
		PURGING COOL Cool water is being purged from the storage tank and the heat pump is not allowed to come on. This may continue for up to 30 minutes and then preheat will begin.
		PREHEAT TANK The heat pump is heating the storage tank while the zones remain off. This may continue for up to 30 minutes and then the zones are allowed to call for heating.

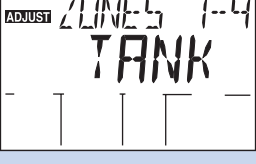
Adjust Menu (1 of 6)

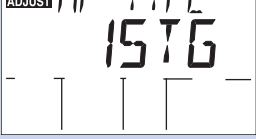
The Adjust menu items are the programmable settings used to determine what type of system to operate.

Item Field	Range	Description
	AUTO, COOL, HEAT, BKUP, OFF Default = AUTO	MODE SECTION C AUTO - Automatic heat pump switchover between heating and cooling. Boiler or backup heat is brought on automatically as needed for DHW/Setpoint loads and space heating. COOL - Heat pump only operates in cooling mode. Backup heat only operates for DHW/Setpoint loads. HEAT - Heat pump only operates in heating mode. Boiler or backup heat is brought on automatically as needed for DHW/Setpoint loads and space heating. BKUP - Heat pump is disabled. Boiler or backup heat is brought on automatically as needed for DHW/Setpoint loads and space heating. OFF - Heat pump is disabled. Boiler or backup heat is disabled.
	T, T+M, T+B, T+MB Default = T	WATER TEMPERATURE SECTION B T - Only a tank loop is configured. T + B - Tank and boiler loops are configured. T + M - Tank and mix loops are configured. T + MB - Tank, mix, and boiler loops are configured.
	TANK, BOIL, MIX Default = TANK	ZONES 1-4 SECTION B Selects which water temperature zones 1-4 are associated with. TANK - links zones 1-4 to the tank loop. BOIL - links zones 1-4 to the boiler loop. MIX - links zones 1-4 to the mixing loop. Note: This setting is not adjustable when Water Temperature is set to T (tank).
	GEO, AIR Default = GEO	HEAT PUMP SOURCE SECTION E Select whether the heat pump is an air-source (AIR) or water-source (GEO) heat pump.
	1STG, 2STG, ROT Default = 1STG	HEAT PUMP TYPE SECTION E 1STG - operates a single stage heat pump. 2STG - operates a two-stage heat pump. ROT - operates two heat pumps and rotates them every 48 hours difference in run time.

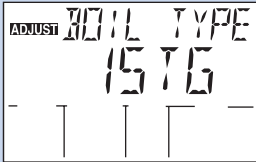
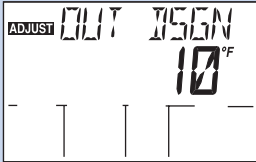
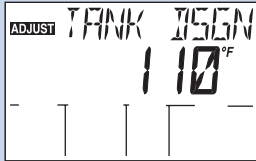
Adjust Menu (2 of 6)

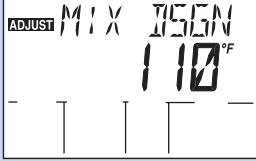
Item Field	Range	Description
	<p>NONE, AUX, XFER, VAR Default = NONE</p> <p>Access: <i>Installer</i> Set to:</p>	<p>BACKUP <i>SECTION B</i></p> <p>NONE - No backup heat source is available. AUX - An auxiliary heat source (electric or instantaneous water heater) is either inside or in-line with the storage tank. XFER - A boiler is the backup heat source. Backup heat is transferred from the boiler loop to the heat pump loop with the transfer pump. VAR - A boiler is the backup heat source. Backup heat is transferred from the boiler loop to the tank loop with the variable speed pump.</p> <p>Note: If boil and mix water temperatures are configured, this item is automatically set to XFER and is no longer displayed.</p>
	<p>1STG, 0-10, 4-20, EMS1, EMS2 Default = 1STG</p> <p>Access: <i>Installer</i> Set to:</p>	<p>BOILER TYPE <i>SECTION B</i></p> <p>The type of boiler connected to the control. 1STG - single one-stage on-off boiler 0-10 - 0-10 V (dc) modulating boiler 4-20 - 4-20 mA modulating boiler EMS1 - tekmar boiler staging controls EMS2 - Viessmann modulating boilers</p> <p>Note: This item is only available when a boil water temperatures have been selected.</p>
	<p>-60 to 45°F (-51 to 7°C) Default = 10°F (-12°C)</p> <p>Access: <i>Installer</i> Set to:</p>	<p>OUTDOOR DESIGN <i>SECTION D</i></p> <p>The outdoor air temperature used in the heating curves that determine the tank, mix, and boiler target temperatures. Typically set to the temperature of the coldest day of the year.</p>
	<p>70 to 200°F (21 to 93.5°C) Default = 110°F (43.5°C)</p> <p>Access: <i>Installer</i> Set to:</p>	<p>TANK DESIGN <i>SECTION D</i></p> <p>The supply water temperature required for the tank zones to heat the building on the typical coldest day of the year. Recommendations:</p> <ul style="list-style-type: none"> • High mass radiant floor = 120°F (50°C) • Low mass radiant floor = 140°F (60°C) • Fancoil or air handling unit = 190°F (90°C) • Copper fin-tube convector = 180°F (80°C) • Radiators = 160°F (70°C) • Low profile baseboard = 150°F (65°C)
	<p>OFF, 70 to 110°F (21 to 43.5°C) Default = OFF</p> <p>Access: <i>Installer</i> Set to:</p>	<p>TANK MINIMUM <i>SECTION D</i></p> <p>The minimum allowed tank target temperature. This only applies when a zone on the tank bus calls for heat.</p>
	<p>70 to 200°F (21.0 to 93.5°C) Default = 110°F (49°C)</p> <p>Access: <i>Installer</i> Set to:</p>	<p>MIX DESIGN <i>SECTION D</i></p> <p>The supply water temperature required for the mix zones to heat the building on the typical coldest day of the year. Recommendations:</p> <ul style="list-style-type: none"> • High mass radiant floor = 120°F (50°C) • Low mass radiant floor = 140°F (60°C) • Fancoil or air handling unit = 190°F (90°C) • Copper fin-tube convector = 180°F (80°C) • Radiators = 160°F (70°C) • Low profile baseboard = 150°F (65°C) <p>Note: This item is only available when a mix water temperature has been selected.</p>



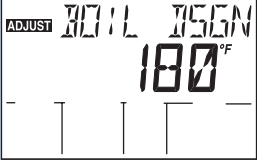
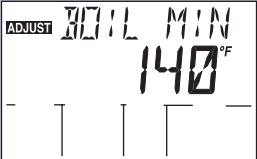
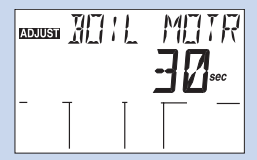
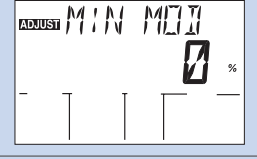
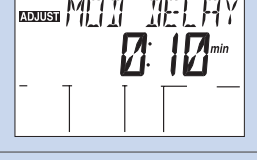
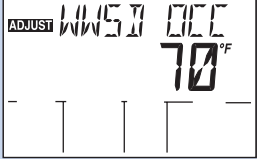
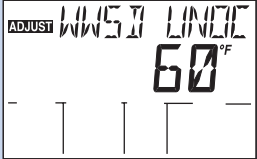
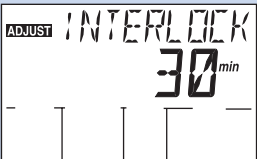

Adjust Menu (3 of 6)

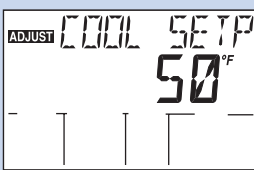
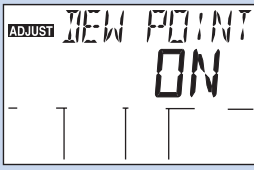
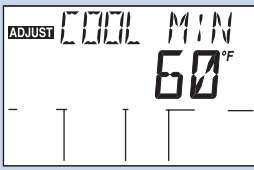
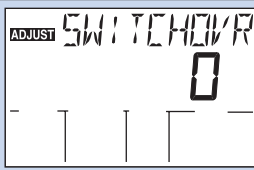
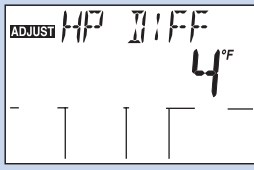
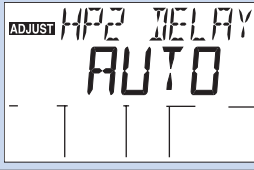
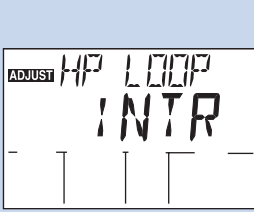
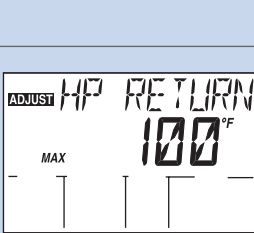
Item Field	Range	Description
	70 to 200°F (21 to 93.5°C) Default = 180°F (82°C)	BOILER DESIGN SECTION D The supply water temperature required for the boiler zones to heat the building on the typical coldest day of the year. Recommendations: <ul style="list-style-type: none"> • High mass radiant floor = 120°F (50°C) • Low mass radiant floor = 140°F (60°C) • Fancoil or air handling unit = 190°F (90°C) • Copper fin-tube convactor = 180°F (80°C) • Radiators = 160°F (70°C) • Low profile baseboard = 150°F (65°C) Note: This item is only available when a boil water temperature has been selected.
	OFF, 80 to 180°F (26.5 to 82°C) Default = 140°F (60°C) if BOIL TYPE = 1STG Default = OFF if BOIL TYPE = 0-10, 4-20, EMS1, or EMS2	BOILER MINIMUM SECTION D The minimum allowed boiler target temperature and temperature at which the mixing device begins to provide boiler protection against cold return water temperatures. The variable speed pump operates at low percent output when the boiler supply temperature drops below this setting. Recommendations: <ul style="list-style-type: none"> • Condensing gas or electric boiler = OFF • Non-condensing gas and oil boilers = 140°F (60°C) Note: This item is only available when a boil water temperature has been selected. If Boiler Type is 0-10 V (dc), 4-20 mA, EMS1 or EMS2, this setting is defaulted to Off. The mixing device does not provide boiler protection when Boiler Type is set to EMS1 or EMS2.
	10 to 230 seconds Default = 30 seconds	BOILER MOTOR SPEED SECTION G Time in seconds from full-close to full-open of modulating boiler actuator. Note: Item is only available when BOIL TYPE is set to 0-10 or 4-20.
	0 to 50% Default = 0%	BOILER MINIMUM MODULATION SECTION G Minimum physical output to modulating boiler. Note: Item is only available when BOIL TYPE is set to 0-10 or 4-20.
	0:00 to 3:00 minutes Default = 0:10 minutes	BOILER MODULATION DELAY SECTION G Modulating boiler stays at MIN MOD output for this length of time before beginning to modulate to control temperature. Note: Item is only available when BOIL TYPE is set to 0-10 or 4-20.
	40 to 100°F (4.5 to 38°C) Default = 70°F (21°C)	WWSO OCCUPIED SECTION D The system's Warm Weather Shut Down temperature during Occupied periods or when a schedule is not used.
	40 to 100°F (4.5 to 38°C) Default = 60°F (15.5°C)	WWSO UNOCCUPIED SECTION D The system's Warm Weather Shut Down temperature during Unoccupied periods. Note: Item is only available when a schedule or User Switch is present on the system.
	10 to 180 minutes Default = 30 minutes	INTERLOCK SECTION C Set the minimum delay between the heat pump switching from heat to cool or cool to heat. Note: The interlock delay only applies when the MODE is set to AUTO.

Adjust Menu (4 of 6)

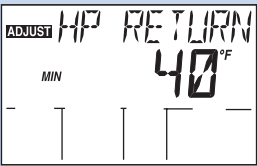
Item Field	Range	Description
	35 to 70°F (4 to 21°C) Default = 50°F (10°C)	COOL SETPOINT SECTION D Tank setpoint that will be maintained when in cooling mode (not for floor cooling).
	ON, OFF Default = ON	DEW POINT SECTION C ON - a humidity sensor is required in order to operate floor cooling. OFF - no humidity sensor is required to perform floor cooling. The floor-cooling supply target will be the value of the COOL MINIMUM setting.
	OFF, 40 to 75°F (4.5 to 24°C) Default = 60°F (15.5°C)	COOL MINIMUM SECTION C Minimum supply temperature to deliver when: <ul style="list-style-type: none"> • Performing floor cooling for a loop • Limiting a zone's target supply temperature based on dewpoint considerations. The target for floor-cooling or dewpoint limiting is calculated as the higher of: <ul style="list-style-type: none"> • 2 °F above the dewpoint or this setting.
	O, B Default = O	SWITCHOVER SECTION E O - Close O/B contacts to operate heat pump in cool mode. B - Close O/B contacts to operate heat pump in heat mode.
	2 to 20°F (1 to 11°C) Default = 4°F	HEAT PUMP DIFFERENTIAL SECTION E Differential around the tank sensor which the heat pump will cycle its compressor (half above and half below target).
	AUTO, 2:00 to 20:00 minutes Default = AUTO	HEAT PUMP 2 DELAY SECTION E The minimum time delay between the Y1 and Y2 stages of the heat pump. Note: Item is only available when HP TYPE = 2STG or ROT.
	INTR, ON Default = INTR	HP LOOP SECTION B INTR - The HP Loop Pump will operate together with the heat pump including pre & post purge ON - The HP Loop Pump will operate whenever heat is being drawn from or pushed into the tank: <ul style="list-style-type: none"> • When heat pump operates including pre & post purge • When there is a tank call • When there is a mix call • When the transfer pump is running
	70 to 180°F (21 to 82°C) Default = 100°F (38°C)	HP RETURN MAXIMUM SECTION E Prevents the heat pump from operating in heating mode if the heat pump return temperature exceeds this setting.

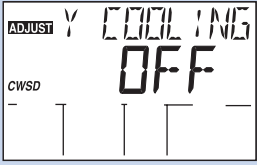
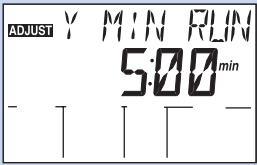
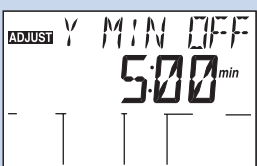
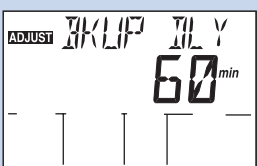
Adjust Menu (5 of 6)

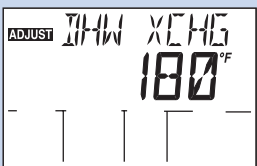
Item Field	Range	Description
	30 to 70°F (1 to 21°C) Default = 40°F (4.5°C)	HP RETURN MINIMUM SECTION E Prevents the heat pump from operating in cooling mode if the heat pump return temperature falls below this setting.
Access: Installer Set to:		
	OFF, -10 to 60°F (-23.5 to 15.5°C) Default = OFF	BALANCE POINT SECTION E Prevents the heat pump from operating in heating mode if the outdoor air temperature falls below this setting. Note: This item is only available when HP SOURCE = AIR.
Access: Installer Set to:		
	OFF, 35 to 100°F (OFF, 1.5 to 38.0°C) Default = OFF	Y COOLING CWSD SECTION E Prevents the heat pump from operating in cooling mode if the outdoor air temperature falls below this setting (Cold Weather Shut Down).
Access: Installer Set to:		
	0:30 to 10:00 minutes Default = 5:00 minutes	Y MINIMUM RUN-TIME SECTION E Minimum compressor run-time for the heat pump.
Access: Installer Set to:		
	0:30 to 10:00 minutes Default = 5:00 minutes	Y MINIMUM OFF-TIME SECTION E Minimum compressor off-time for the heat pump.
Access: Installer Set to:		
	10 to 180 minutes, OVR Default = 60 minutes	BACKUP DELAY SECTION E The time that heat pump(s) have to run at full output before the backup heat source is called upon. OVR (override) - When selected, the backup source will not be called upon for heat unless the MODE is set to BKUP or the heat pump is locked out on high return temperature or outdoor temperature. Note: This item is only available when BACKUP is set to other than NONE.
Access: Installer Set to:		
	OFF, 1, 2, 3, 4, 5 Default = OFF	DHW MODE SECTION F Sets the mode of DHW operation: OFF - No DHW generation. 1 - Parallel piping with no priority 2 - Parallel piping with priority. 3 - Primary/secondary piping with no priority 4 - Primary/secondary piping with priority 5 - DHW pre-heat Note: Modes 1-4 are only available when the WATERTEMP item has been set to T+B or T+MB. Mode 5 is only available when the WATERTEMP item has been set to T.
Access: Installer Set to:		
	100 to 200°F (38 to 93.5°C) Default = 180°F (82°C)	DHW EXCHANGE SECTION F Boiler target required to satisfy a DHW demand. Note: Item is only available when the DHW Mode is set to 1 to 4.
Access: Installer Set to:		

Adjust Menu (6 of 6)

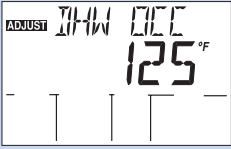
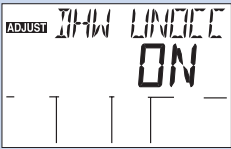
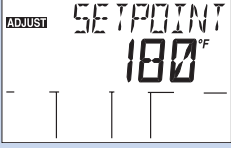
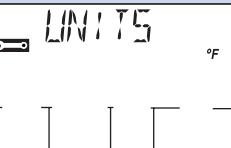
Item Field	Range	Description
	70 to 180°F (21 to 82°C) Default = 125°F (51.5°C) If DHW MODE = 1-4 Default = 90°F (32°C) If DHW MODE = 5 Access: <i>Installer</i> Set to:	DHW OCCUPIED SECTION F Selects the temperature of the indirect DHW tank when DHW MODE = 1-4. Selects the temperature of the DHW pre-heat tank when DHW MODE = 5. Note: Item is only available when a DHW sensor is installed and the DHW Mode is set to 1 to 5.
	ON, OFF Default = ON Access: <i>Installer</i> Set to:	DHW UNOCCUPIED SECTION F Selects whether or not the indirect DHW tank should be heated to during Unoccupied time periods. Note: Item is only available when a DHW sensor is installed, the DHW Mode is set to 1 to 5 and a schedule is available or a User Switch is present on the system.
	60 to 200°F (15.5 to 93.5°C) Default = 180°F (82°C) Access: <i>Installer</i> Set to:	SETPOINT SECTION H Boiler target to satisfy a setpoint demand.
	°F or °C Default = °F Access: <i>User</i> Set to:	UNITS Selects units for temperature display.

Monitor Menu (1 of 2)

The Monitor menu items provide information about the system's operation and performance. To clear any item back to default, press and hold the Up and Down buttons while viewing that item.

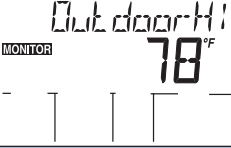
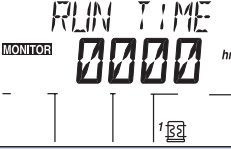
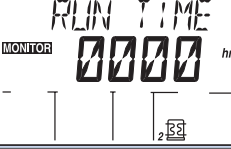
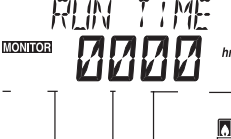



Item Field	Range	Description
	-76 to 149°F (-60.0 to 65.0°C) Access: <i>User</i>	OUTDOOR LOW Records the lowest outdoor temperature since the item was last reset. Press and hold the Up and Down buttons while viewing to reset.
	-76 to 149°F (-60.0 to 65.0°C) Access: <i>User</i>	OUTDOOR HIGH Records the highest outdoor temperature since the item was last reset. Press and hold the Up and Down buttons while viewing to reset.
	0 to 9999 Hours Default = 0 hr Access: <i>User</i>	RUN TIME (HEAT PUMP STAGE 1) The total 'on' time of the Y1 relay since the item was last reset. Press and hold the Up and Down buttons while viewing to reset.
	0 to 9999 Hours Default = 0 hr Access: <i>User</i>	RUN TIME (HEAT PUMP STAGE 2) The total 'on' time of the Y2 relay since this item was last reset. Press and hold the Up and Down buttons while viewing to reset. Note: Item is only available when HP TYPE = 2STG or ROT.
	0 to 9999 Hours Default = 0 hr Access: <i>User</i>	RUN TIME (BOILER) The total 'on' time of the backup relay since the item was last reset. Press and hold the Up and Down buttons while viewing to reset. Note: Item is only available when WATERTEMP = T + B or T+MB.

Monitor Menu (2 of 2)

Item Field	Range	Description
	0 to 9999 Hours Default = 0 hr Access: <i>Installer</i>	RUN TIME (AUXILIARY) The total 'on' time of the Backup relay since the item was last reset. Press and hold the Up and Down buttons while viewing to reset. Note: Item is only available when BACKUP = AUX.
	0 to 9999 Hours Default = 0 hr Access: <i>Installer</i>	RUN TIME (TRANSFER PUMP) The total running time of the Transfer Pump since the item was last reset. Press and hold the Up and Down buttons while viewing to reset. Note: Item is only available when BACKUP = XFER
	0 to 9999 Hours Default = 0 hr Access: <i>Installer</i>	RUN TIME (VARIABLE SPEED PUMP) The total running time of the Variable Speed Pump since the item was last reset. Press and hold the Up and Down buttons while viewing to reset. Note: Item is only available when BACKUP = VAR.
	0 to 9999 Hours Default = 0 hr Access: <i>Installer</i>	RUN TIME (HP LOOP PUMP) The total running time of the HP Loop Pump since the item was last reset. Press and hold the Up and Down buttons while viewing to reset.
	0 to 9999 Hours Default = 0 hr Access: <i>Installer</i>	RUN TIME (TANK PUMP) The total running time of the Tank System Pump since this item was last reset. Press and hold the Up and Down buttons while viewing to reset.
	0 to 9999 Hours Default = 0 hr Access: <i>Installer</i>	RUN TIME (MIX SYSTEM PUMP) The total running time of the Mix System Pump since this item was last reset. Press and hold the Up and Down buttons while viewing to reset. Note: Item is only available when WATERTEMP = T + M or T + MB.
	0 to 9999 Hours Default = 0 hr Access: <i>Installer</i>	RUN TIME (BOIL SYSTEM PUMP) The total running time of the Boil System Pump since this item was last reset. Press and hold the Up and Down buttons while viewing to reset. Note: Item is only available when WATERTEMP = T + B or T + MB.
	0 to 9999 Hours Default = 0 hr Access: <i>Installer</i>	RUN TIME (DHW PUMP) The total running time of the DHW Pump since this item was last reset. Press and hold the Up and Down buttons while viewing to reset. Note: Item is only available when DHW MODE ≠ OFF.
	---, -35 to 273 °F (-37 to 134 °C) Access: <i>Installer</i>	DEW POINT MIX Highest dewpoint of all humidity sensors on the mix loop. Note: Item is only available when WATERTEMP = T + M or T + MB and a humidity sensor has been detected on the mix bus.
	---, -35 to 273 °F (-37 to 134 °C) Access: <i>Installer</i>	DEW POINT TANK Highest dewpoint of all humidity sensors on the tank loop. Note: Item is only available when a humidity sensor has been detected on the tank bus.
	---, -35 to 273 °F (-37 to 134 °C) Access: <i>Installer</i>	DEW POINT BOIL Highest dewpoint of all humidity sensors on the boiler loop. Note: Item is only available when WATERTEMP = T + B or T + MB and a humidity sensor has been detected on the boiler bus.

Toolbox Menu (1 of 1)

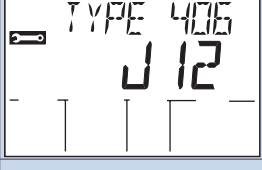
The Toolbox Menu is a location for system information and Test functions. If any errors are present on the system, they will be located at the beginning of this menu.

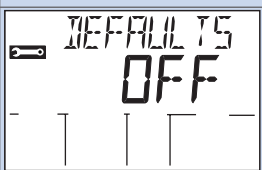
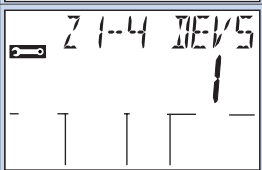
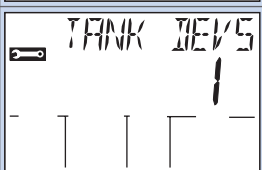
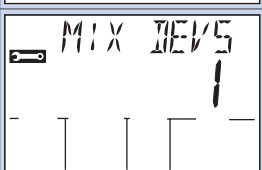
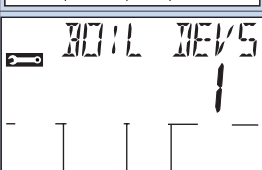
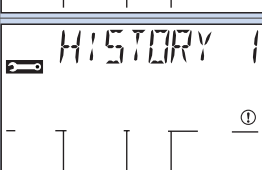
Item Field	Range	Description
	ON or OFF Default = OFF Access: Installer	USER TEST Begins the test routine which tests the main control's functions. See the Testing the Control section for more details. Use the up button to turn the User Test On.
	ON or OFF Default = OFF Access: Installer	MAX HEAT When selected, control operates the system up to maximum set temperatures. Will operate up to 24 hours, or can be manually turned Off. See the Max Heat section for more details.
	Flashes Between J12 09A to 09Z Access: User	TYPE AND SOFTWARE VERSION Displays the type number of the product, followed by the current software version beneath.
	INST (Installer) or USER Default = INST Access: User	ACCESS LEVEL Selects the access level of the control, which determines the Menu items available. USER provides the most limited level of access and shows the fewest possible items. When set to USER, all thermostats are locked and the number of thermostat settings available are reduced.
	OFF, SEL Default = Off Access: Installer	FACTORY DEFAULTS Loads the factory default settings. Hold the Up and Down buttons for 1 second until SEL is shown.
	0 to 4 devices Access: Installer	ZONE 1-4 DEVICES Displays the number of tN2 thermostats connected to the House Control on zones 1-4. These thermostats could be assigned to be on the Tank, Mix or Boil bus.
	0 to 24 devices Access: Installer	TANK DEVICES Displays the number of devices connected to the Tank bus expansion terminals, tN4 and C.
	0 to 24 devices Access: Installer	MIX DEVICES Displays the number of devices connected to the Mix bus expansion terminals, tN4 and C. Note: Item is only available when the Mix bus is enabled.
	0 to 24 devices Access: Installer	BOIL DEVICES Displays the number of devices connected to the Boil bus expansion terminals, tN4 and C. Note: Item is only available when the Boil bus is enabled.
	See Troubleshooting Guide Access: Installer	HISTORY 1-5 Displays a history of any past errors that have occurred on the system. Will clear after 30 days, or press Up and Down buttons for 1 second to manually clear. The last 5 history items will display if present.

Sequence of Operation

tekmarNet® System

Section A

tekmarNet® is a family of products that use communication to operate the HVAC system in a comfortable and efficient manner. The House Control is the central component in a tekmarNet® system and requires tekmarNet®2 (tN2) Thermostats to be directly connected to the control.

The tekmarNet®4 (tN4) Expansion terminals can link the House Control with other tekmarNet® components:

- Wiring Centers 313, 314, 315, 316 - Add additional zones
- tN2 and tN4 Thermostats - Add thermostats
- tN4 Timer 033 - Adds 4 programmable schedules
- tN4 User Switch 479 - Provides a system override for vacations and holidays
- tN4 Setpoint Control 161 - Control hot tubs, pools and more

System Setup

Section B

Selecting Water Temperatures (Bus)

There are three possible water temperatures that the House Control 406 can operate and they are called:

- Tank (T)
- Mix (M)
- Boil (B)

The Tank water temperature must always be used and is common to all applications. The Mix and/or Boil water temperatures can be added according to the system requirements. Use the WATERTEMP setting in the Adjust Menu to configure the proper water temperatures for the application. The following table references application drawings with different water temperatures selected.

Application	Water Temperatures
A406-1	Tank
A406-2	Tank & Mix & Boil
A406-3	Tank & Boil
A406-4	Tank & Boil
A406-5	Tank & Mix & Boil

Assign Zones 1-4

There are four tN2 zones on the House Control 406 that have a 24 V (ac) output to operate a zone valve. These zones can be set to the tank, mix or boil temperature using the ZONE 1-4 setting in the adjust menu. The available options change depending on the WATER TEMPERATURE setting.

NOTE: When the WATER TEMPERATURE setting is set to tank plus mix and boil, the Mix or Boiler bus is limited to the 4 on-board connections to the 406. This configuration isolates the 4 on-board zones from communicating with the Gateway 482 or 483.

Selecting a Backup

A backup heat source is required to satisfy the heating load if the heat pump cannot maintain the tank target. If the heat pump can no longer operate in heating mode or if it has run at full output for the BKUP DLY time, the backup is called upon for heating. The BACKUP setting in the Adjust Menu can be configured in the following ways:

NONE

No backup heat source is available.

AUX (Auxiliary)

An electric resistance element in the storage tank, or some other auxiliary heat source is the backup. Once enabled, the Backup relay will operate with a 10°F (5.5°C) differential around the tank target temperature while applying a 30 second minimum on and off time.

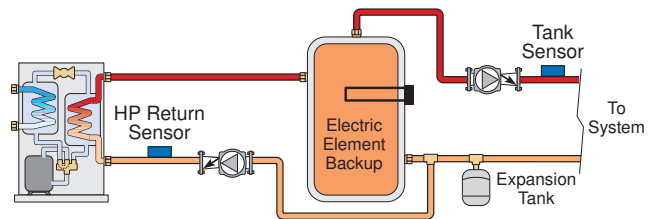

For an electric water heater as backup, see A406-1.

XFER (Transfer Pump)

A boiler is the backup heat source. Backup heat is transferred from the boiler loop to the heat pump loop with the Transfer pump. This is only selectable if a boiler water temperature has been configured. Once enabled, the Transfer pump and Boiler pump will operate with a 10°F (5.5°C) differential around the tank target temperature while applying a 30 second minimum on and off time. The boiler will cycle to maintain its target.

It is useful to pipe the boiler on the upstream side of the storage tank to buffer any high water temperatures coming from the boiler loop from going directly into the tank zones.

Note: Boiler return protection is not available when selecting this type of backup.

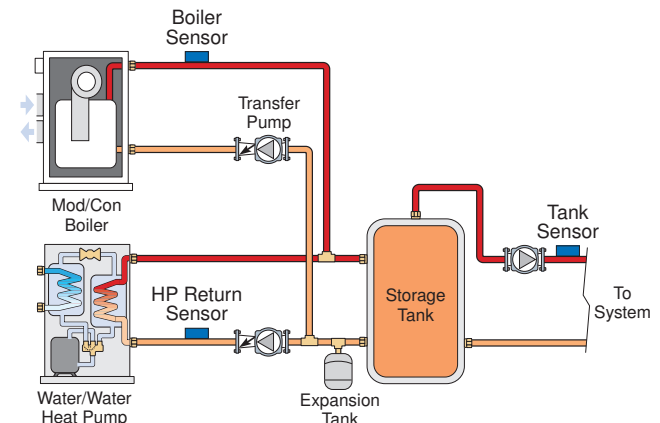

For Transfer Pump backup, see A406-2, A406-3 and A406-5.

VAR (Variable Speed Pump)

A boiler is the backup heat source. Backup heat is transferred from the boiler loop to the tank loop with the Variable Speed Pump. This is only selectable if a boiler water temperature has been selected and no mixing water temperature has been selected. Once enabled, the Variable Speed Pump will operate to maintain the desired tank target.

Note: Boiler return protection is available when selecting this type of backup. The Variable Speed Pump operates at minimum speed whenever the boiler supply temperature falls below the boiler minimum setting or when the control is doing DHW or Setpoint priority.

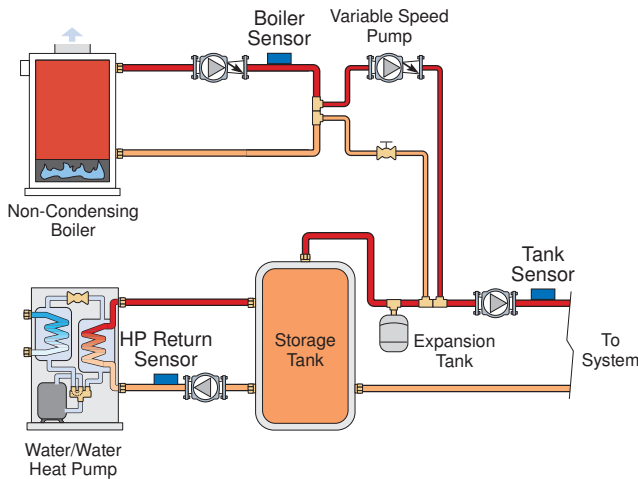

For Variable Speed Pump backup, see A406-4

Selecting a Boiler Type

A boiler may be used as a backup heat source to supplement the heat pump during heating mode. The boiler may also heat domestic hot water, setpoint loads and space heating zones on the boiler bus. The House Control 406 has five boiler types to choose from. Use the BOIL TYPE setting in the Adjust Menu to select one of the following:

1 STG

The Backup relay is used to operate a single stage on/off boiler to maintain the boiler target temperature.

0-10

The Mod dc/mA output uses 0-10 V (dc) to operate a modulating boiler to maintain the boiler target temperature. The Backup relay is also used to give a boiler enable to allow the modulating boiler to go through the ignition sequence. The Backup relay may not be required on all modulating boilers.

4-20

The Mod dc/mA output uses 4-20 mA to operate a modulating boiler to maintain the boiler target temperature. The Backup relay is also used to give a boiler enable to allow the modulating boiler to go through the ignition sequence. The Backup relay may not be required on all modulating boilers.

EMS1

The Mod dc/mA output uses 0-10 V (dc) to communicate a desired boiler target water temperature to a tekmar stager that accepts an EMS signal. 1 V (dc) corresponds to 50°F (10°C) and 10 V (dc) corresponds to 210°F (99°C).

EMS2

The Mod dc/mA output uses 0-10 V (dc) to communicate a desired boiler target water temperature to a Viessmann modulating boiler. 0 V (dc) corresponds to off, 2.2 V (dc) corresponds to 81°F (27°C), and 10 V (dc) corresponds to 176°F (80°C).

HP Loop Pump Operation

Due to different piping arrangements, the HP Loop Pump may operate in two different ways. Use the HP LOOP setting in the Adjust Menu to select the proper operation for this pump.

INT (Intermittent)

The HP Loop Pump will operate together with the heat pump compressor including pre-purge and post-purge times. This operation is suitable when using a 3-port or 4-port storage tank to hydraulically isolate the HP Loop from the Tank Loop.

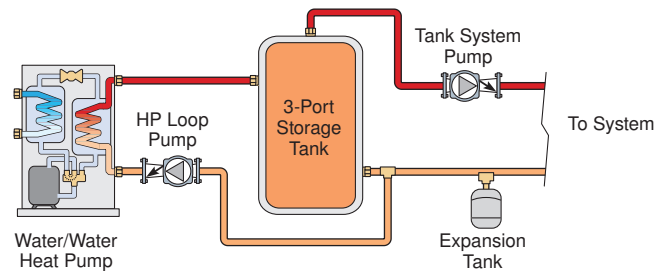

3-Port Storage Tank Piping, HP LOOP = INT

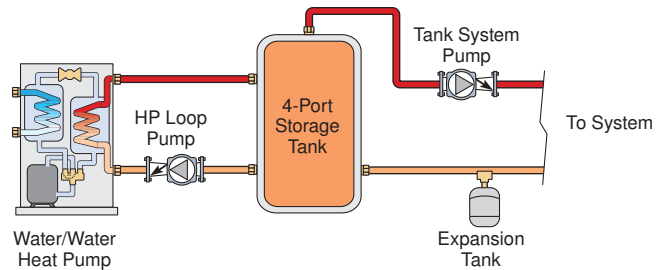

4-Port Storage Tank Piping, HP LOOP = INT

ON

The HP Loop Pump will operate together with the heat pump compressor including pre-purge and post-purge times and it will operate whenever water is being pumped into or away from the storage tank. This includes:

- When there is a call on the Tank Bus
- When there is a call on the Mix Bus
- When the Transfer Pump is on

This operation is suitable when using a 2-port storage tank and primary/secondary piping is used to hydraulically isolate the HP Loop from the Tank Loop.

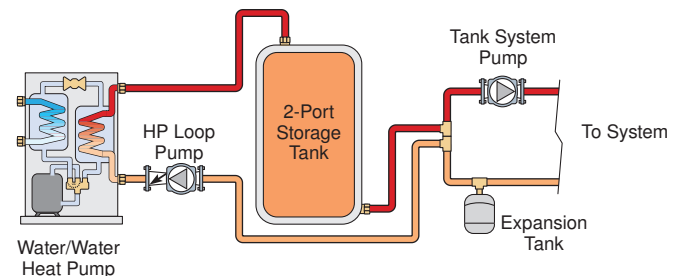

2-Port Storage Tank Piping, HP LOOP = ON

Mode

There are five different modes that the heat pump and backup can operate in. Use the MODE setting in the Adjust Menu to select one of the following modes:

AUTO

The heat pump and backup will automatically switchover between heat and cool mode.

COOL

While in cool mode, the heat pump will satisfy any cooling calls from the zones on the Tank and Mix bus. The backup will operate automatically to satisfy DHW and Setpoint calls for heat on the Boil bus. "Cool" is displayed in the Mode status field while in cool mode.



Note: For hydronic cooling with a fancoil, use tekmarNet® 2 thermostat 530 or tekmarNet® 4 thermostat 540 with a date code of **December 2011** or newer.

HEAT

While in heat mode, the heat pump will satisfy any heating calls from the zones on the Tank and Mix bus. The backup will operate automatically to satisfy DHW, Setpoint, Tank, Mix and Boil calls for heat. "Heat" is displayed in the Mode status field while in heat mode.

**BKUP (Backup)**

While in backup mode, the heat pump is disabled. The backup will operate automatically to satisfy DHW, Setpoint, Tank, Mix and Boil calls for heat. "Backup" is displayed in the Mode status field while in backup mode.

**OFF**

While in off mode, the heat pump and backup are disabled.

Interlock Delay

The interlock delay is the minimum time between heat/cool switchovers while in the AUTO mode. Use the INTERLOCK setting in the Adjust Menu to select an interlock time between 10 minutes and 180 minutes.

Switchover

Switchover is determined by polling the thermostats on the Tank and Mix bus. When enough thermostats are calling for the opposite mode and the interlock delay has elapsed, a switchover will occur. This ensures that the system actually requires the new tank mode before switching over. Switchover includes purging and preheat or precool.

Purging

Once Switchover begins, the heat pump is forced off. All zones that are off remain off and all zones that become satisfied and turn off also remain off. The remaining zones are allowed to continue calling for 30 minutes or until the tank temperature changes by 15°F (8°C). This allows the tank to be purged before the heat pump is allowed to switch modes and reverse the water temperature of the tank. While this is happening,

the words "PURGING HEAT" or "PURGING COOL" will be displayed in the view menu depending if the tank is currently in the heat or cool mode.

Pre-Heat or Pre-Cool

Once the purging has completed, the heat pump is allowed to preheat or precool the tank. All zones are prevented from calling for 30 minutes or until the tank temperature reaches within 10°F (5.5°C) of its new target. This allows time for the heat pump to switch the tank temperature to its new target before turning on zones again.

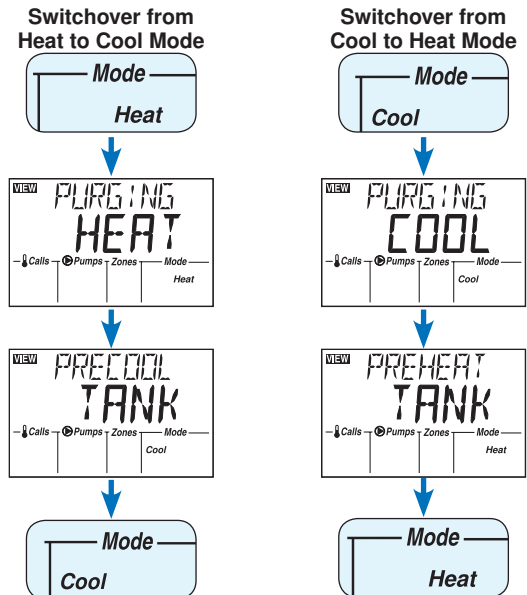
**Floor Cooling**

Floor cooling is a form of radiant base load cooling. It reduces the sensible cooling load, and care must be taken to avoid removing moisture from the air causing condensation (latent cooling). It works well in zones with lots of glass and high solar gains by extracting heat away from the slab before it is able to heat the room. 'Floor' is displayed in the Mode status field while doing floor cooling.

**Enable Floor Cooling**

For floor cooling to occur, a compatible tekmarNet® thermostat must have floor cooling turned on. Use the FLOOR COOL (or F C) setting in the thermostat to turn floor cooling ON.

With Humidity Sensor

In areas where there is a potential for condensation to form on the cooling surface, floor cooling requires at least one humidity sensor on the network. The humidity sensor measures relative humidity. Knowing the relative humidity and the room temperature, the House Control 406 is able to calculate the dewpoint temperature. Keeping the surface temperature of the slab above dewpoint while doing floor cooling will prevent condensation from forming.

For best results, multiple humidity sensors may be used. The House Control 406 will choose the zone with the highest dewpoint to calculate the floor cooling target.

Set the DEW POINT item in the Adjust Menu to ON for floor cooling with a humidity sensor on the network.

Without Humidity Sensor

Floor cooling may be performed without a humidity sensor. This operation is only recommended in dry areas where humidity is not a concern. Set the DEW POINT item in the Adjust Menu to OFF for floor cooling without a humidity sensor on the network.

Conditions For Floor Cooling

The House Control 406 will enter into floor cooling when the following conditions have been met:

1. The 406 is in Warm Weather Shut Down (WWSD)
2. There has been no heat calls for 2 hours
3. There are no cooling or dehumidification calls on the bus that cause the target to go below the dewpoint temperature

At the thermostat, floor cooling will stop when the room temperature cools to the heating target plus 3°F (1.5°C).

Floor Cooling Target

During floor cooling, the target water temperature is the higher of:

1. The dewpoint temperature plus 2°F (1°C) if DEW POINT = ON, or
2. The COOL MIN setting in the Adjust Menu

This ensures the surface of the slab never reaches the dewpoint temperature causing moisture to condense.

Note: For floor cooling, use tekmarNet® 2 thermostats 527, 528, 529, 530 or tekmarNet® 4 thermostats 537, 538, and 540 with a date code of **December 2011** or newer.

Hydronic Operation

Section D

Hydronic Heat & Cool Calls

When a thermostat, or other tekmarNet® device calls for heating or cooling, the House Control 406 will register the call on the corresponding bus and display the call in the “Calls” box of the status field. Calls for heating or cooling may come from the tank or mix bus. The boil bus may only call for heating.

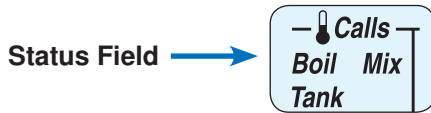

Cool Setpoint

For a cooling call other than floor cooling, the House Control 406 will operate the bus at an adjustable cooling setpoint. Use the COOL SETP setting in the Adjust Menu to select a cooling setpoint.

Outdoor Temperature Reset

Once a space heating call is present, the target water temperature for that bus is determined using outdoor temperature reset together with indoor temperature feedback from the thermostats. A heating curve is used for each bus to determine the outdoor temperature reset calculation. The heating curve operates based on the principle that a buildings heat loss increases with colder outdoor temperatures. See the default heating curves for each bus below:

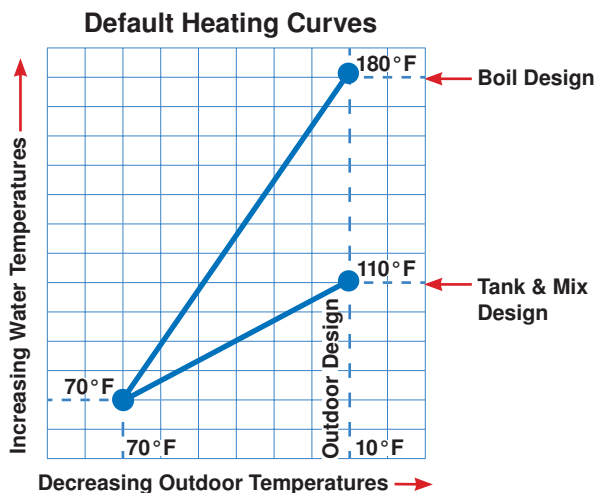

Weather Shut Down (WWSD) when the outdoor temperature rises above the WWSD temperature. Use the WWSD OCC and WWSD UNOC settings in the Adjust Menu to set an appropriate WWSD temperature.

Outdoor Design

The outdoor design is the lowest outdoor temperature on the typical coldest day of the year. At this outdoor temperature, the heating curve will calculate the design water temperature to be the target. Use the OUT DSGN setting in the Adjust Menu to select an appropriate outdoor design temperature for your city.

Design Water Temperature

There are up to three design water temperatures to set on the House Control 406 depending on the water temperatures configured. These are: boil design, mix design and tank design. The House Control 406 will target the design water temperature when the outdoor temperature reaches the outdoor design. These two parameters set the upper point for each heating curve. Adjust the BOIL DSGN, MIX DSGN, and TANK DSGN settings in the Adjust Menu.

Boiler and Tank Minimum

The BOIL MIN and TANK MIN settings in the Adjust Menu set the lowest water temperature that the control is allowed to use as the boiler target and tank target respectively.

It is useful to set a minimum target water temperature when using a fan coil to prevent blowing cold air into the room.

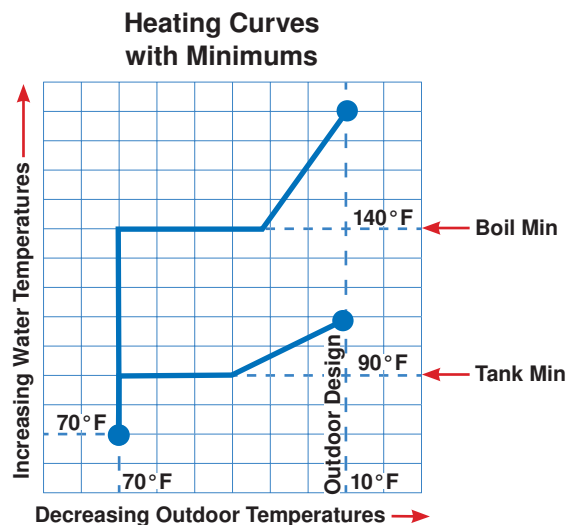

Warm Weather Shut Down (WWSD)

During warmer weather, heating of the rooms is typically no longer required. To prevent energy waste from unnecessary heat pump and backup operation, the control goes into Warm

Boiler Minimum Protection

When operating a non-condensing boiler, it is important to prevent cool water from returning to the boiler. Cold return water temperatures create flue gas condensation, which if left too long, can severely damage the boiler.

If VAR is selected as a backup type, the variable speed pump will reduce its speed in order to maintain the boiler sensor above the BOIL MIN setting. The BOIL MIN setting is the lowest water temperature that the control is allowed to use as a boiler target.

If the boiler supply water temperature is cooler than the boiler minimum setting, the control reduces the output of the variable speed pump. This limits the amount of cool return water to the boiler and allows the boiler return water temperature to recover. Once the boiler supply temperature exceeds the boiler minimum setting, the variable speed pump will return to normal operation.

Note: The Variable Speed Pump does not provide boiler minimum protections when the BOIL TYPE is set to EMS1 or EMS2.

Maximum Targets

The control has a maximum target of + 10°F (+5.5°C) higher than the DSGN setting for all heating curves. The control will operate the boiler so that the boiler supply temperature will never exceed 210°F (99.0°C).

Heat Pump Operation

Section E

Number of Heat Pump Stages

The House Control 406 is capable of operating a single heat pump, either one or two stage. Use the HP TYPE setting in the Adjust Menu to select whether a second stage is available (1STG, 2STG).

Equal Run Time Rotation

If the system has two heat pumps that require equal run time, set the HP TYPE setting to ROT (Rotate). This way the two heat pumps will rotate their starting order when one heat pump accumulates 48 hours more run time than the other.

Heat Pump Source

The House Control 406 only supports heat pump systems where the load side is hydronic, or water based. The source side however can either be air source or water source. Use the HP SOURCE setting in the Adjust Menu to select if the heat pump is air-to-water (AIR) or water-to-water (GEO).

Staging

When two heat pumps or a two-stage heat pump is being used (HP TYPE = 2STG or ROT), the staging method of the 406 changes depending on the HPSOURCE setting: AIR or GEO.

With an air source heat pump selected, the 406 will stage on sequentially and off sequentially. This allows the supply water temperature to be kept close to the target.

AIR Source Staging



With a geo source heat pump selected, the 406 will stage on sequentially, but turns off both stages at once. This allows the ground to naturally recover better since there are longer periods of time between the heat pump transferring heat to or from the ground source.

GEO Source Staging

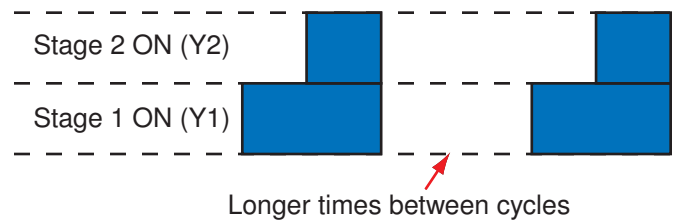

Stage Delay

The House Control 406 stages two heat pumps or a two-stage heat pump automatically. A manual stage delay can also be set between 2 and 20 minutes which forces the second stage to remain off for this adjustable amount of time. Use the HP2 DELAY setting in the Adjust Menu to select either an automatic or manual stage delay when two heat pump stages have been configured (HP TYPE = 2STG or ROT).

O/B Switchover

Depending on the manufacturer, a heat pump may be designed to satisfy a dominant heating load or dominant cooling load. A reversing valve on the heat pump is used to switch between heating and cooling and is energized with either an O or B terminal on the heat pump. The House Control 406 has an O/B output which can operate in the following ways:

- O = Heat pump normally operates in heat mode. Energize O to operate the heat pump in cool mode

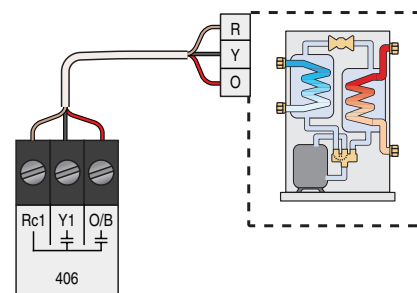

- B = Heat pump normally operates in cool mode. Energize B to operate the heat pump in heat mode

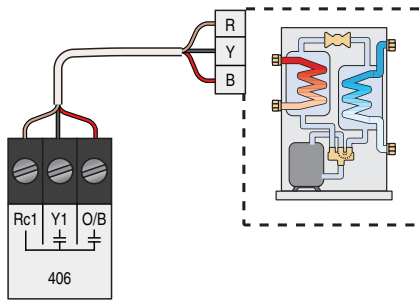

Use the SWITCHOVR setting in the Adjust Menu to select the proper operation of the O/B terminal.

Backup Delay

To allow the heat pump to operate at full output for some adjustable amount of time before the backup heat source is allowed to come on, a backup delay is used. Use the BKUP DLY setting in the Adjust Menu to set an appropriate backup delay time. When OVR is selected, the backup source will not be called upon for heat unless the MODE is set to BKUP or the heat pump is locked out on high return temperature or outdoor temperature. This ensures that the heat pump is being used to its full potential during heating.

HP Return Water Temperature Limit

At certain return water temperatures, it may not be economical to keep the heat pump operating due to low coefficient of performance (COP). This will occur in heating when the return water temperature is too high, and in cooling when the return water temperature is too low. These values will differ from one heat pump to another. Use the HP RETURN MAX and HP RETURN MIN settings in the Adjust Menu to set the heat pump return water temperature limits for heating and cooling.

Outdoor Air Temperature Limit

Heating - For AIR Source Heat Pumps Only

At low outdoor air temperatures, it may not be economical to keep an air source heat pump operating during heating due to low COP. These values will differ from one air source heat pump to another. Use the BALNCE PT setting in the Adjust Menu to set the low outdoor air temperature limit for heating.

Cooling

During cool weather, cooling of the rooms is typically no longer required. The control shuts down the heat pump when the outdoor temperature falls below an adjustable temperature to prevent energy waste from unnecessary heat pump operation during cooling. Use the Y COOLING CWSD setting in the Adjust Menu to set the low outdoor air temperature limit for cooling.

Note: the CWSD icon is displayed in status field of the display when the outdoor temperature falls below either the BALNCE PT or Y COOLING CWSD settings in the Adjust Menu.



Heat Pump Differential

The differential operates by closing the Y1 contact when the tank water temperature is 1/2 of the differential below the tank target. As the tank temperature reaches 1/2 of the differential above the tank target, the Y1 contact is opened, turning the heat pump off.

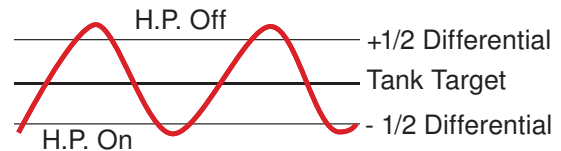

DHW Operation

Section F

DHW Calls

A DHW Call is required in order for the control to provide heat to a DHW tank. Once the control registers a DHW Call, it will display the DHW icon in the "Calls" box of the status field. This can be done in one of three ways:



DHW Tank Aquastat

If a DHW aquastat (mechanical switch) is used to apply a DHW Call, the tank is heated to the aquastat temperature setting. A dry contact is applied across the DHW Call terminals on the House Control.

- Use the DHW XCHG setting in the Adjust Menu to set the boiler target required to satisfy this type of DHW call.

DHW Tank Sensor

A DHW tank sensor provides superior temperature control of the tank compared to an aquastat. The House Control automatically detects whether a DHW sensor is installed.

The upper limit of the DHW temperature is set by the DHW OCC setting in the Adjust Menu. The DHW tank differential is fixed to 6°F (3°C).

- When using a DHW Tank Sensor, the boiler target is set to the DHW OCC setting plus 40°F (22°C).

tekmarNet® Setpoint Control with Sensor

A DHW Call is provided through the tekmarNet® system. This can be done through the tN4 Boil Expansion terminals with a tekmarNet® setpoint device such as a Setpoint Control 161 or 162.

- When using a tekmarNet® Setpoint Control, the boiler target is set to the devices Exchange Supply setting.

DHW Mode

The control has five different settings available for DHW Mode that affect pump operation. The required DHW Mode setting will depend on the piping arrangement of the DHW tank and whether or not priority for the DHW tank is necessary. DHW Priority stops or limits the delivery of heat to the building heating system while the DHW tank calls for heat. This allows for quick DHW tank temperature recovery.

DHW MODE 1 - DHW in Parallel no Priority

When a DHW Call is present, the DHW Pump is activated. The Boiler System Pump does not turn on, but may operate based on either a Boiler, Setpoint or Backup Call. It is assumed that the DHW Pump will provide adequate flow through the heat exchanger and the boiler.

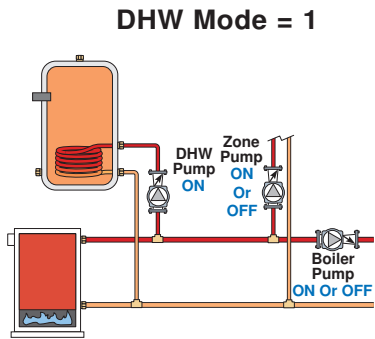

DHW MODE 2 - DHW in Parallel with Priority

When a DHW Call is present, the DHW Pump is activated. The Boiler System Pump and all boiler temperature zones are shut off through tekmarNet® communication to achieve DHW priority. It is assumed that the DHW Pump will provide adequate flow through the heat exchanger and the boiler.

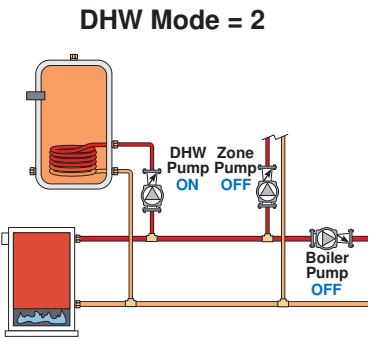

DHW MODE 3 - DHW in Primary / Secondary no Priority

When a DHW Call is present, the DHW Pump and the Boiler System Pump are operated. Boiler temperature zones can turn on if required.

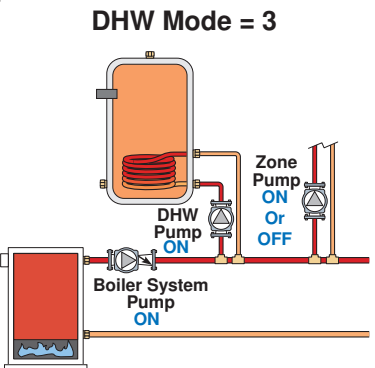

DHW MODE 4 - DHW in Primary / Secondary with Priority

When a DHW Call is present, the DHW Pump and the Boiler System Pump are operated. All boiler temperature zones are shut off through tekmarNet® communication to achieve DHW priority.

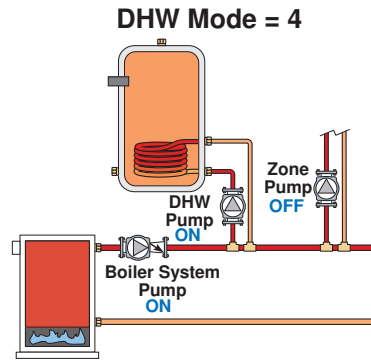

DHW Mode 5 - DHW Pre-Heat with Priority

DHW Mode 5 may be used in electric only systems where the heat pump provides heat to a DHW preheat tank. This mode is only available when the WATERTEMP setting in the Adjust Menu is set to tank (T).

The DHW sensor is located inside the preheat tank and targets a 90°F (32°C) tank temperature by default. No other DHW call is accepted. Use the DHW OCC setting in the Adjust Menu to adjust the preheat tank target.

The heat pump will target a water temperature 20°F (11°C) higher than the preheat tank target at the return sensor. The heat pump target is limited by the HP RETURN MAX setting in the Adjust Menu.

When a DHW Call is present from the DHW Sensor, the DHW Pump is activated. The HP Loop Pump is shut off while zones on the tank bus are allowed to continue to call for heat. This prioritizes DHW preheat while allowing tank zones to use any available heat in the storage tank.

It is assumed that the DHW Pump will provide adequate flow through the preheat tank and the heat pump.

Note: DHW pre-heat will not occur when there is a cooling call on the Tank bus.

DHW Mode = 5

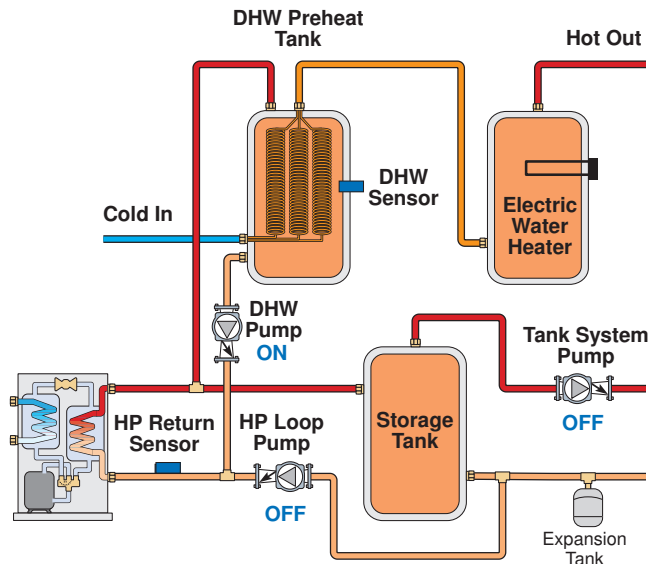

Conditional DHW Priority

If the boiler supply temperature is maintained at or above the required temperature during DHW generation, this indicates that the boiler has enough capacity for DHW and possibly heating as well. As long as the boiler supply temperature is maintained near the target, DHW and heating occur simultaneously.

DHW Priority Override

To prevent the building from cooling off too much or the possibility of a potential freeze up during DHW priority, the control limits the amount of time for DHW priority during cold weather. During warm weather the DHW priority is 120 minutes. During cold weather the DHW priority is 15 minutes. Once the allowed time for priority has elapsed, the control overrides the DHW priority and resumes space heating for 15 minutes. It will then revert back to DHW Priority and repeat.

DHW Priority Override Time

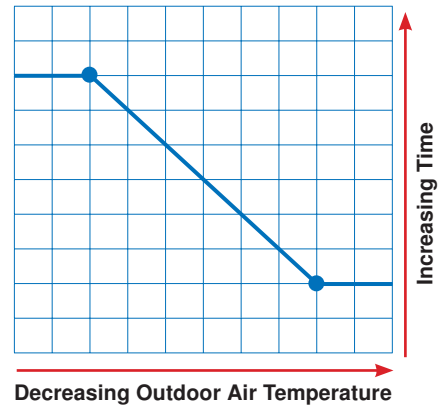

DHW Post Purge

After the DHW Call is removed, the control performs a purge on the boiler. The control shuts off the boiler and continues to operate the DHW pump and the Boiler System pump if applicable. This purges the residual heat from the boiler into the DHW tank. The control continues this purge for a maximum of two minutes. The control also stops the purge if the boiler supply temperature drops below the current boiler target temperature.

Boiler Operation

Section G

The 406 is able to operate a single on-off or modulating boiler. For proper operation of the boiler, the 406 must be the only control that determines when the boiler is to fire.

***Important note:** The operating control in the boiler, also known as an aquastat, remains in the burner circuit and acts as a secondary upper limit on the boiler temperature. The boiler operator temperature setting can be adjusted above 210°F (99°C), which is the absolute maximum target on the 406.

Boiler Target Temperature

The boiler target temperature is the temperature which the control is trying to operate the boiler. There are four items that determine the boiler target temperature:

- Boil Call
- DHW Call
- Setpoint Call
- Backup Mode

If the control receives more than one of these at the same time, it will operate the boiler at the highest target.

The control displays the boiler target in the View Menu. If the control does not presently have a boiler target, '---' is displayed on the LCD.

Boiler Differential

Both on-off and modulating boilers are operated with a differential. In some cases, a modulating boiler must be operated with a differential while operating at low fire because this indicates the load is smaller than the minimum modulation of the boiler. For modulating boilers, the differential no longer applies once operating the boiler above low fire.

The differential operates by closing the boiler contact when the boiler supply water temperature is 1/2 of the differential below the boiler target temperature. As the supply temperature reaches 1/2 of the differential above the boiler target temperature, the boiler is shut off.

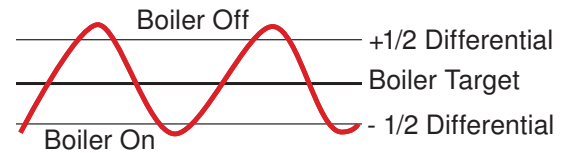

In order to decrease temperature swings and increase boiler efficiency, the Auto Differential feature automatically adjusts the operating differential of the boiler based on the heating load. As the load increases, the differential will decrease to minimize temperature swings. As the load decreases, the differential will increase to prevent short cycling. This can significantly improve operating efficiency and prevent equipment failures through excessive cycling.

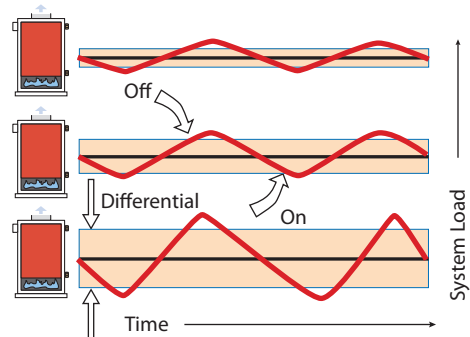

On-Off Boiler Operation

The 406 operates a single hot-water on-off boiler to maintain the boiler target within a differential. The boiler target is the average temperature and the boiler supply temperature can fluctuate by 1/2 of the differential above and below of the boiler target.

Modulating Boiler Operation

The 406 can operate a single hot-water modulating boiler using the Mod dc/mA output and the Backup contact. Not all boilers require the use of the Backup contact.

The control operates the boiler by first switching the Backup contact to allow the modulating boiler to go through the ignition sequence. A 0-10 V (dc) or 4-20 mA analog signal is then used to modulate the boiler firing rate starting from 50% (5 V (dc) or 12 mA signal) for 30 seconds.

After the 30 second delay has elapsed, the control will then allow the boiler to modulate down to the minimum modulation setting and hold it there for the MOD DELAY time.

After the MOD DELAY has elapsed, the control uses PID logic to change the boiler firing rate signal in order to satisfy the boiler target temperature. When the firing rate signal is reduced down to the MIN MOD setting and the boiler supply temperature exceeds the boiler target by 1/2 of the differential, the control will shut off the burner.

Boiler Motor Speed

The Motor Speed is the amount of time the boiler requires to go from 0% modulation to 100% modulation.

Gas valve actuating motors have a design time from fully closed to fully opened which can be found in the manufacturer's manual. The Motor Speed should be set to this time.

The Motor Speed setting for a Variable Frequency Drive (VFD) is the amount of time required to go from a stopped position to 100% fan speed. Since a VFD has a very quick response rate, it may be necessary to increase the Motor Speed setting in order to increase the stability of the boiler modulation.

Use the BOIL MOTR setting in the Adjust Menu to select an appropriate boiler motor speed.



Essential Settings for House Control 406 with Common Modulating Boilers

Boiler Model	BOIL TYPE	BOIL MOTR (sec)	MIN MOD (%)	MOD DELAY (min)	Required Equipment from Boiler Manufacturer	Boiler Control Setting			Wiring Terminals					
						Parameter	Setting	Reference	Backup	Mod dc/mA +	Mod dc/mA -			
Buderus GB142, 162, 312	0-10	10	30	0:10	EM10 Module	None	None	None			2	1		
Burnham Alpine	4-20	30	0	0:10	None	Central Heating Modulation Source	4-20mA	p.109 I&O Manual	1	2	9	10		
Dunkirk Q95M-200	0-10	10	18	1:45	HAM 0-10VDC Module	Parameter 34 [P .34]	[- - 04]	p.3 Ham Installation Instructions			+	-		
Heat Transfer Products Elite	0-10	24	16	0:00	None	Function 16	0-10 Volt	p.57 Installation Manual			+	-		
						Function 17	Fan Speed							
Heat Transfer Products Munchkin	0-10	60	16	0:00	Munchkin Interface Board	Function 16	1	p.60 Boiler Manual			Purple	Yellow		
						Function 17	1							
Laars NeoTherm	4-20	30	0	0:50	None	None	None	None	5	6	4	3		
Lochinvar Knight	0-10	16	20	0:10	None	H3	Active	p.24 Service Manual			33	34		
Lochinvar Sync	0-10	16	20	0:10	None	Demand conf	3	p.19 Service Manual			19	20		
Peerless PureFire REV2	0-10	50	20	0:00	Interface Adapter PFA-1	Heating Mode	Mode 5	p.43 I&O Manual			16	15		
Triangle Tube Prestige Solo	0-10	90	18	2:05	None	Parameter 45	02	p.54 I&M Manual			17+	18-		
Weil-McLain Ultra Series 3	0-10	60	20	0:30	None	ADD'L HEAT DEMAND	Type 4	p.64 Boiler Manual			6	5		
Viessmann Vitodens 100	EMS 2	N/A	N/A	N/A	Input Module 0-10V OT	None	None	None			1	4		

For updated information or wiring details, check the service bulletin page on www.tekmarControls.com.

Boiler Modulation Delay

The modulation delay is determined by the boiler manufacturer. It is the amount of time that the burner must operate before the internal boiler control allows an external signal to operate the burner.

Use the MOD DELAY setting in the Adjust Menu to select an appropriate modulation delay time.

Boiler Minimum Modulation

The Minimum Modulation is the lowest signal the control can send to modulate the boiler. This operates the boiler at low fire. Use the MIN MOD setting in the Adjust Menu to select an appropriate boiler minimum modulation.

- Refer to the boiler manufacturer's literature to determine the minimum output voltage V (dc) or current (mA) that the boiler will successfully operate at.

For 0-10 V (dc):

Minimum Modulation =

$$\frac{\text{Boiler's Minimum Input Signal}}{10 \text{ V (dc)}} \times 100\%$$

For 4-20 mA:

Minimum Modulation =

$$\frac{\text{Boiler's Minimum Input Signal} - 4\text{mA}}{16 \text{ mA}} \times 100\%$$

Example:

A boiler requires a 1.8 V (dc) signal to fire the boiler at low fire. The boiler can be modulated to 10 V (dc) where it reaches high fire.

$$\text{Minimum Modulation} = \frac{1.8 \text{ V}}{10 \text{ V}} \times 100\% = 18\%$$

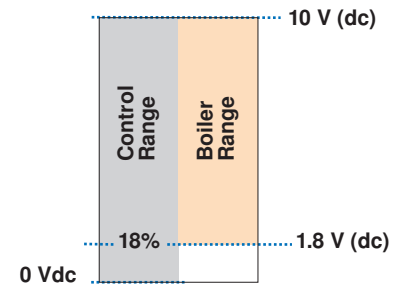

Setpoint Operation

Section H

Setpoint Calls

A Setpoint Call is required in order for the control to provide heat to a setpoint load, such as a spa, pool, or snowmelt load. Once the control registers a setpoint Call, it will display the Setpoint icon in the "Calls" box of the status field. This can be done in two ways:

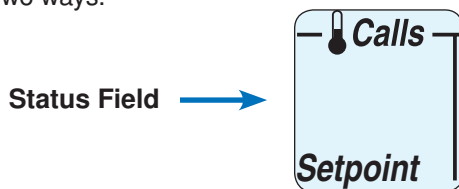

Contact Closure

A dry contact is applied across the Setpoint Call terminals on the 406.

- Use the SETPOINT setting in the Adjust Menu to set the boiler target required to satisfy this setpoint call.

tekmarNet® Setpoint Control with Sensor

A Setpoint Call is provided through the tekmarNet® system. This can be done through the tN4 Expansion terminals with a setpoint device such as a Setpoint Control 161 or 162.

- When using a tekmarNet® Setpoint Control, the boiler target is set to the devices Exchange Supply setting.

Setpoint Operation

The control can operate to satisfy the requirements of a setpoint call on the boiler loop in addition to a space heating call, DHW call or Backup call. A setpoint call overrides the current boiler outdoor reset temperature and WWSD setting in order to provide heat to the setpoint load.

When the control receives a Setpoint Call:

- The boiler will operate to maintain the Setpoint temperature set in the Adjust Menu, or on the tekmarNet® Setpoint control.
- The Boiler System Pump does not turn on, but may operate based on either a Boiler, DHW or Backup Call.

It is assumed that the Setpoint pump will provide adequate flow through the setpoint load and the boiler.

Setpoint calls will also be responded to when the system is in *Away*, which can be set using a 479 User Switch.

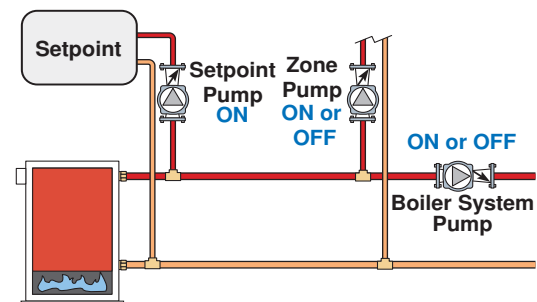

Note: Setpoint operation has no priority.

The House Control 406 operates the variable speed pump output for mixing. The Variable % bar graph in the “Zones” box of the status field indicates the approximate speed of the pump.

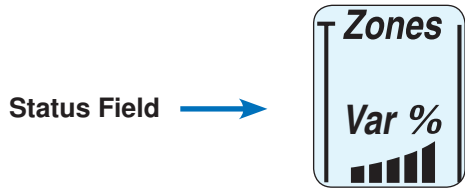

Variable Speed Pump

A standard wet rotor circulator can be connected to the Variable Speed Pump output on the back of the control. The control varies the circulator speed to maintain the correct mixed supply water temperature at the mix supply sensor. For heating, the hot tank water temperature will be mixed down, and for cooling the chilled tank water temperature will be mixed up.

For correct sizing and piping of the variable speed pump, refer to essay E 021.

Note: Pumps manufactured with an internal variable speed controller are not compatible with the House Control.

The table below gives a list of manufacturer approved pump models for the Variable Speed Pump output.

Manufacturer approved pump models for Variable Speed Pump output.

Grundfos (F)				Taco				B & G			Armstrong			Wilco					
15-42	15-58	26-64	43-75	003	007	0010	0012	NRF 9	NRF 22	NRF 33	Astro			Star S16FX			Star		
**	***	**	***								25BU	30	50	*	**	***	S21FX	17FX	30F

*Speed 1, **Speed 2, ***Speed 3

These circulators have been tested and approved by the manufacturer for use with tekmar variable speed electronics.

The House Control 406 operates six different pump outputs on the back side of the enclosure. The “Pumps” box in the status field indicates which pumps are operating at any given time.

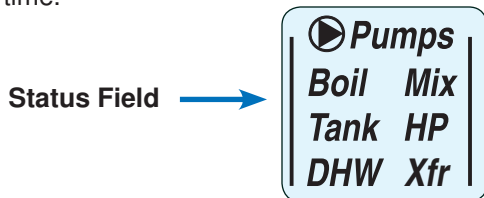

Boiler System Pump

The boiler system pump operates whenever all the following conditions are met:

- A Boil Call is present and the thermostat calling for heat has the Heat 1 pump setting set to On.
- OR a Backup Call is present and BACKUP is set to XFER or VAR.
- OR a DHW Call is present and DHW MODE is set to 3 or 4.
- There is no DHW or Setpoint priority.
- The control is not in Warm Weather Shut Down.

Tank System Pump

The tank system pump operates whenever all the following conditions are met:

- A Tank Call is present.
- A thermostat is calling for heating or cooling and the Heat 1 Pump setting is set to On.
- The control is not in Warm Weather Shut Down.

Note: The tank system pump does not run when only a Mix Call is present.

Mix System Pump

The mix system pump operates whenever all the following conditions are met:

- A Mix Call is present.
- A thermostat is calling for heating or cooling and the Heat 1 Pump setting is set to On.
- The control is not in Warm Weather Shut Down.

Pump Exercising

The control operates each pump every three days for 10 seconds to help prevent corrosion and/or precipitate build up that that would cause the pump to seize. The control ensures that no heat is supplied to the zones during exercising.

HP Loop Pump

The HP Loop Pump operation is explained in Section B.

DHW Pump

The DHW Pump operation is explained in Section F.

Transfer Pump

The Transfer Pump operation is explained in Section B.





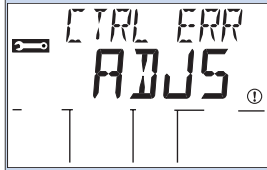
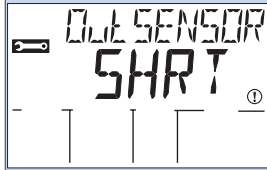
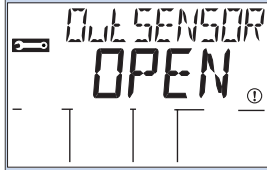
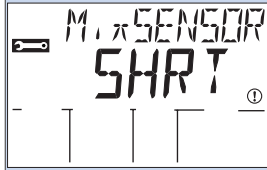
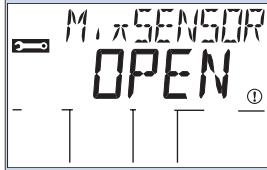
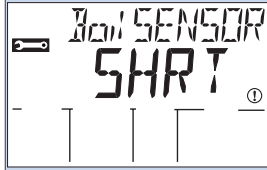
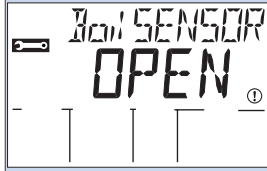
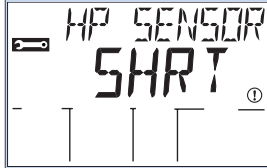

Troubleshooting

It is recommended to complete all wiring to ensure trouble free operation. Should an error occur, simply follow these steps:

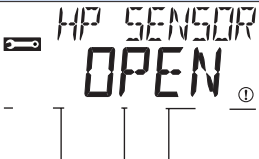

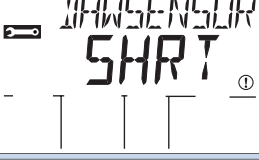
1. **Find:** If the House Control or tekmarNet® Thermostat flashes  on the screen, it is indicating a problem on the system.
2. **Identify:** Use the Menu button to locate the Toolbox Menu. The Error code should appear as the first item.
3. **Solve:** Using the lookup chart below, match the Error code to the one on the control. Use the Description in the chart to solve the problem.

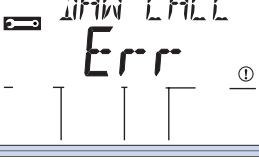
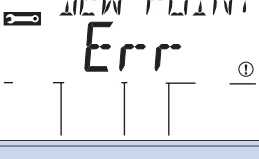
Error Messages (1 of 3)	
Error Message	Description
	<p>ADJUST ERROR</p> <p>The control failed to read the Adjust menu settings, and reloaded the factory default settings. Operation stops until all the Adjust menu settings are checked.</p> <p>Note: To clear the error, the access level must be set to Installer and each setting in the Adjust menu must be checked.</p>
	<p>OUTDOOR SENSOR SHORT CIRCUIT</p> <p>Due to a short circuit, the control failed to read the outdoor sensor. As a result, the control assumes an outdoor temperature of 32°F (0°C) and continues operation. Locate and repair the problem as described in the “Test the Sensor Wiring” section.</p>
	<p>OUTDOOR SENSOR OPEN CIRCUIT</p> <p>Due to an open circuit (disconnected or broken wire), the control failed to read the outdoor sensor. As a result, the control assumes an outdoor temperature of 32°F (0.0°C) and continues operation. Locate and repair the problem as described in the “Test the Sensor Wiring” section.</p>
	<p>MIX SENSOR SHORT CIRCUIT</p> <p>Due to a short circuit, the control failed to read the Mix supply sensor. As a result, the control operates the variable speed pump at a fixed output as long as there is a Mix Call. Locate and repair the problem as described in the “Test the Sensor Wiring” section.</p>
	<p>MIX SENSOR OPEN CIRCUIT</p> <p>Due to an open circuit (disconnected or broken wire), the control failed to read the Mix supply sensor. The control operates the variable speed pump at a fixed output as long as there is a Mix Call. Locate and repair the problem as described in the “Test the Sensor Wiring” section.</p>
	<p>BOILER SENSOR SHORT CIRCUIT</p> <p>Due to a short circuit, the control failed to read the boiler sensor. The control no longer controls the boiler. Instead, the control provides a boiler enable and the boiler operates on its aquastat/limit until the sensor is repaired. The control will not operate the boiler contact if the Boil Minimum setting is set to Off. Locate and repair the problem as described in the “Test the Sensor Wiring” section.</p>
	<p>BOILER SENSOR OPEN CIRCUIT</p> <p>Due to an open circuit, the control failed to read the boiler sensor. The control no longer controls the boiler. Instead, the control provides a boiler enable and the boiler operates on its aquastat/limit until the sensor is repaired. The control will not operate the boiler contact if the Boil Minimum setting is set to Off. Locate and repair the problem as described in the “Test the Sensor Wiring” section.</p>
	<p>HEAT PUMP RETURN SENSOR SHORT CIRCUIT</p> <p>Due to a short circuit, the control failed to read the heat pump return sensor. The control still operates the heat pump, but the HP RETURN MAX and HP RETURN MIN settings are no longer used. Locate and repair the problem as described in the “Test the Sensor Wiring” section.</p>

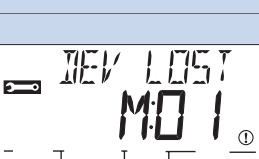
Error Messages (2 of 3)

Error Message	Description
 <p>The LCD display shows "HP SENSOR" on the top line and "OPEN" on the second line. A small circled '1' is visible in the bottom right corner of the display area.</p>	<p>HEAT PUMP RETURN SENSOR OPEN CIRCUIT</p> <p>Due to an open circuit (disconnected or broken wire), the control failed to read the heat pump return sensor. The control still operates the heat pump, but the HP RETURN MAX and HP RETURN MIN settings are no longer used. Locate and repair the problem as described in the "Test the Sensor Wiring" section.</p>
 <p>The LCD display shows "TANKSENSOR" on the top line and "SHRT" on the second line. A small circled '1' is visible in the bottom right corner of the display area.</p>	<p>TANK SENSOR SHORT CIRCUIT</p> <p>Due to a short circuit, the control failed to read the tank sensor. The control no longer operates the heat pump or backup. Locate and repair the problem as described in the "Test the Sensor Wiring" section.</p>
 <p>The LCD display shows "TANKSENSOR" on the top line and "OPEN" on the second line. A small circled '1' is visible in the bottom right corner of the display area.</p>	<p>TANK SENSOR OPEN CIRCUIT</p> <p>Due to an open circuit (disconnected or broken wire), the control failed to read the tank sensor. The control no longer operates the heat pump or backup. Locate and repair the problem as described in the "Test the Sensor Wiring" section.</p>
 <p>The LCD display shows "DHWSENSOR" on the top line and "SHRT" on the second line. A small circled '1' is visible in the bottom right corner of the display area.</p>	<p>DOMESTIC HOT WATER SENSOR SHORT CIRCUIT</p> <p>Due to a short circuit, the control failed to read the DHW sensor. As a result, the control no longer heats the DHW tank. Locate and repair the problem as described in the "Test the Sensor Wiring" section. DHW tank heating will resume once the sensor problem is corrected. The error message self clears once the error condition is corrected.</p>
 <p>The LCD display shows "DHWSENSOR" on the top line and "OPEN" on the second line. A small circled '1' is visible in the bottom right corner of the display area.</p>	<p>DOMESTIC HOT WATER SENSOR OPEN CIRCUIT</p> <p>Due to an open circuit (disconnected or broken wire), the control failed to read the DHW sensor. As a result, the control no longer heats the DHW tank. Locate and repair the problem as described in the "Test the Sensor Wiring" section. DHW tank heating will resume once the sensor problem is corrected. The error message self clears once the error condition is corrected.</p>
 <p>The LCD display shows "DHW CALL" on the top line and "Err" on the second line. A small circled '1' is visible in the bottom right corner of the display area.</p>	<p>DOMESTIC HOT WATER CALL ERROR</p> <p>A DHW sensor and a DHW call have been applied at the same time. The DHW tank will not be heated until the DHW call signal is removed. The error message self clears once the error condition is corrected.</p>
 <p>The LCD display shows "DEW POINT" on the top line and "Err" on the second line. A small circled '1' is visible in the bottom right corner of the display area.</p>	<p>DEW POINT ERROR</p> <p>The DEW POINT item in the adjust menu is set to ON, but no humidity sensor has been detected on the network. Either install a humidity sensor on the network, or set the DEW POINT item to OFF. The error message self clears once the error condition is corrected.</p>
 <p>The LCD display shows "DEV LOST" on the top line and "001" on the second line. A small circled '1' is visible in the bottom right corner of the display area.</p>	<p>BOILER DEVICE LOST (b:01 TO b:24)</p> <p>Each tekmarNet® device (thermostat, setpoint control, timer) has an address. The device with this address on the boiler water temperature is no longer reporting back to the 406.</p> <p>The device can be located by either the address, or by going to each device in the building, checking that the LCD is on, and the tekmarNet® communication symbol is on. Trace the wires from the control to the lost device looking for loose or damaged wires.</p> <p>Note: If you deliberately remove a tekmarNet® device, hold the Up and Down buttons to clear this error.</p>
 <p>The LCD display shows "DEV LOST" on the top line and "M01" on the second line. A small circled '1' is visible in the bottom right corner of the display area.</p>	<p>MIX DEVICE LOST (1:01 TO 1:24)</p> <p>Each tekmarNet® device (thermostat, setpoint control, timer) has an address. The device with this address on the mix water temperature is no longer reporting back to the 406.</p> <p>The device can be located by either the address, or by going to each device in the building, checking that the LCD is on, and the tekmarNet® communication symbol is on. Trace the wires from the control to the lost device looking for loose or damaged wires.</p> <p>Note: If you deliberately remove a tekmarNet® device, hold the Up and Down buttons to clear this error.</p>

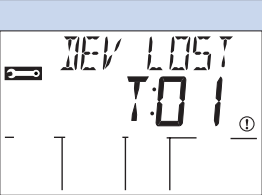
Error Messages (3 of 3)

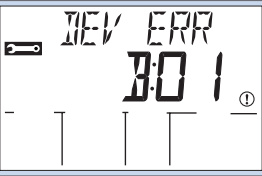
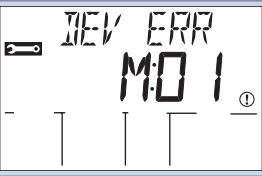
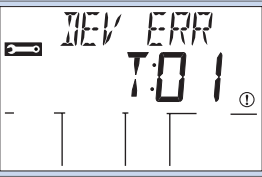
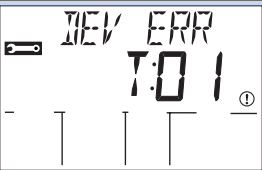
Error Message	Description
	<p>TANK DEVICE LOST (T:01 TO T:24)</p> <p>Each tekmarNet® device (thermostat, setpoint control, timer) has an address. The device with this address on the tank water temperature is no longer reporting back to the 406.</p> <p>The device can be located by either the address, or by going to each device in the building, checking that the LCD is on, and the tekmarNet® communication symbol is on. Trace the wires from the control to the lost device looking for loose or damaged wires.</p> <p>Note: If you deliberately remove a tekmarNet® device, hold the Up and Down buttons to clear this error.</p>
	<p>MASTER DEVICE ERROR</p> <p>More than one master has been detected on the tekmarNet®4 expansion terminals. The 406 is a “Master Device” and no other tekmarNet® reset controls can be added to the tekmarNet®4 expansion terminals. If one has been added, remove it from the system.</p>
	<p>DEVICE ERROR AT ADDRESS B:01 to B:24</p> <p>Each tekmarNet® device (thermostat, setpoint control, timer) has an address. One of the devices on the boiler water temperature has an error. If there is a record of the device address together with the room name, go to that device to correct the error. Otherwise, go to each device in the building, checking for the flashing Warning symbol. Once the error on the device is corrected, the error message will clear.</p>
	<p>DEVICE ERROR AT ADDRESS M:01 to M:24</p> <p>Each tekmarNet® device (thermostat, setpoint control, timer) has an address. One of the devices on the mix water temperature has an error. If there is a record of the device address together with the room name, go to that device to correct the error. Otherwise, go to each device in the building, checking for the flashing Warning symbol. Once the error on the device is corrected, the error message will clear.</p>
	<p>DEVICE ERROR AT ADDRESS T:01 to T:24</p> <p>Each tekmarNet® device (thermostat, setpoint control, timer) has an address. One of the devices on the tank water temperature has an error. If there is a record of the device address together with the room name, go to that device to correct the error. Otherwise, go to each device in the building, checking for the flashing Warning symbol. Once the error on the device is corrected, the error message will clear.</p>
	<p>DEVICE ERROR AT ADDRESS T:01 to T:24</p> <p>Each tekmarNet® device (thermostat, setpoint control, timer) has an address. One of the devices on the tank water temperature has an error. If there is a record of the device address together with the room name, go to that device to correct the error. Otherwise, go to each device in the building, checking for the flashing Warning symbol. Once the error on the device is corrected, the error message will clear.</p>

Frequently Asked Questions

Symptom	Look For...	Corrective Action
LCD display is off	Fuse holder	Control power supply has a 24 V (ac) fuse which if blown, requires replacement.
	Power to control	Use electrical meter to measure 24 V (ac) voltage on input power R and C terminals.
No DHW tank heating	DHW Call on LCD	If a DHW call is present, the control is aware that the DHW tank requires heat.
	DHW tank reading	Ensure the DHW tank temperature is accurate and replace DHW Sensor if necessary.
	Boiler symbol on LCD	If the boiler symbol is on the LCD, there is a problem with the boiler. Ensure the boiler aquastat manual limit is reset to the on position.
	DHW pump symbol on LCD	If the DHW pump symbol is on, check to ensure the DHW pump is in operation by checking for pump vibration or voltage on the pump wiring terminals.
	DHW pump in operation	If DHW pump and boiler are operating, the system may require the boiler system pump to operate to heat the DHW tank. Ensure the DHW Mode setting is set correctly.
No central heating	Heat pump symbol on LCD	If the heat pump symbol is on the LCD, there is a problem with the heat pump. Check the heat pump for faults or reference the manufacturers' literature.
	"MAX" symbol on LCD	The heat pump is prevented from operating due to high return water temperature. Adjust the HP RETURN MAX setting to the heat pump manufacturers' recommended maximum return water temperature for heating.
	WWSD symbol on LCD	Warm Weather Shut Down (WWSD) is an energy saving feature that prevents central heating during the summer. Ensure the outdoor temperature reading is accurate and replace outdoor sensor if necessary. WWSD setting can be increased if heating is required.
	Tank, Mix or Boil Calls on LCD	If there are no Tank, Mix or Boil Calls, there are no thermostats calling for heat.
	DHW Call on LCD	During DHW tank heating, the central heating may not be heated by the boiler.
	System in AWAY	During AWAY, the thermostats operate at a lower temperature. Locate a 'User Switch' and set to Normal to resume heating.
	MODE setting	The mode of the 406 can be set to Auto, Cool, Heat, Backup, or Off. For central heating to occur, ensure the mode is set to either Auto, Heat, or Backup.
No central cooling	"MIN" symbol on LCD	The heat pump is prevented from operating due to low return water temperature. Adjust the HP RETURN MIN setting to the heat pump manufacturers' recommended minimum return water temperature for cooling.
	Cool outdoor air temperature	The heat pump is prevented from operating due to low outdoor air temperature. Adjust the Y COOLING CWSD setting to an appropriate outdoor temperature to stop cooling.
	Tank or Mix Calls on LCD	If there are no Tank or Mix Calls, there are no thermostats calling for cooling.
	System in AWAY	During AWAY, the thermostats operate at a higher temperature. Locate a 'User Switch' and set to Normal to resume heating.
	MODE setting	The mode of the 406 can be set to Auto, Cool, Heat, Backup, or Off. For central cooling to occur, ensure the mode is set to either Auto or Cool.
Boiler short cycling	Burner symbol cycling on and off	Backup using the variable speed injection pump (VAR) requires the balancing valve to be set correctly. Lack of head pressure can lead the injection pump speed to ramp up and down.
Single zone over heating	LCD shows zone on	Thermostats have a differential of +/- 1.5°F of the temperature setting. Due to the display rounding numbers up, heating can appear on when the temperature is 2°F above the setting. This is normal operation.
	LCD shows zone off	Ensure zone valve terminals measure 0 V (ac). Measuring 0 V (ac) indicates mechanical zone valve may have failed in open position. Measuring 24 V (ac) indicates control relay may have failed.
Single zone under heating	LCD shows zone on	Ensure zone valve terminals measure 24 V (ac). Measuring 24 V (ac) indicates mechanical zone valve may have failed in closed position. Measuring 0 V (ac) indicates control relay may have failed.
	LCD shows zone off	Check for calls

Job Record

Item	Setting	Item	Setting
MODE		DEW POINT	
WATERTEMP		COOL MIN	
ZONES 1-4		SWITCHOVER	
HP SOURCE		HP DIFF	
HP TYPE		HP2 DELAY	
BACKUP		HP LOOP	
BOIL TYPE		HP RETURN MAX	
OUT DSGN		HP RETURN MIN	
TANK DSGN		BALNCE PT	
TANK MIN		Y COOLING CWSD	
MIX DSGN		Y MIN RUN	
BOIL DSGN		Y MIN OFF	
BOIL MIN		BKUP DLY	
BOIL MOTR		DHW MODE	
MIN MOD		DHW XCHG	
MOD DELAY		DHW OCC	
WWSD OCC		DHW UNOCC	
WWSD UNOCC		SETPOINT	
INTERLOCK		UNITS	
COOL SETP			

Technical Data

tN2 House Control 406 Heat Pump & Backup, Four Zone Valves	
Literature	406_D, 406_Q, 406_U
Control	Microprocessor control. This is not a safety (limit) control
Packaged weight	1.4 lb. (640 g)
Dimensions	5.5" H x 5.5" W x 2.25" D (140 x 140 x 57 mm)
Enclosure	NEMA 1 rated, blue PC+ABS plastic
Approvals	CSA C US, meets class B: ICES & FCC Part 15
Ambient conditions	Indoor use only, 32 to 104°F (0 to 40°C), RH 90% Noncondensing
Power supply	24 V (ac) ±10% 60 Hz, 100 VA max, Class 2
Control Load	2 VA
Zone, Y1 and O/B Relays	24 V (ac) 3.7 A combined
Y2, Backup Relays	24 V (ac) 5 A
Pump Relays	115 V (ac) 5 A 1/6 hp
Variable Power	115 V (ac) 2.4 A
Pump Power	115 V (ac) 12 A
Boil/Mix modulating output	0 - 10 V (dc) 500 Ω min load impedance, 4 - 20 mA 1 kΩ max load impedance
Sensors	NTC thermistor, 10k Ω @ 77°F (25°C ± 0.2°C) β=3892
- Included	Outdoor Sensor 070 and 4 of Universal Sensors 082
Warranty	Limited 3 Year

Limited Warranty and Product Return Procedure

Limited Warranty *The liability of tekmar under this warranty is limited. The Purchaser, by taking receipt of any tekmar product ("Product"), acknowledges the terms of the Limited Warranty in effect at the time of such Product sale and acknowledges that it has read and understands same.*

The tekmar Limited Warranty to the Purchaser on the Products sold hereunder is a manufacturer's pass-through warranty which the Purchaser is authorized to pass through to its customers. Under the Limited Warranty, each tekmar Product is warranted against defects in workmanship and materials if the Product is installed and used in compliance with tekmar's instructions, ordinary wear and tear excepted. The pass-through warranty period is for a period of twenty-four (24) months from the production date if the Product is not installed during that period, or twelve (12) months from the documented date of installation if installed within twenty-four (24) months from the production date.

The liability of tekmar under the Limited Warranty shall be limited to, at tekmar's sole discretion: the cost of parts and labor provided by tekmar to repair defects in materials and/or workmanship of the defective product; or to the exchange of the defective product for a warranty replacement product; or to the granting of credit limited to the original cost of the defective product, and such repair, exchange or credit shall be the sole remedy available from tekmar, and, without limiting the foregoing in any way, tekmar is not responsible, in contract, tort or strict product liability, for any other losses, costs, expenses, inconveniences, or damages, whether direct, indirect, special, secondary, incidental or consequential, arising from ownership or use of the product, or from defects in workmanship or materials, including any liability for fundamental breach of contract.

The pass-through Limited Warranty applies only to those defective Products returned to tekmar during the warranty period. This Limited Warranty does not cover the cost of the parts or labor to remove or transport the defective Product, or to reinstall the repaired or replacement Product, all such costs and expenses being subject to Purchaser's agreement and warranty with its customers.

Any representations or warranties about the Products made by Purchaser to its customers which are different from or in excess of the tekmar Limited Warranty are the Purchaser's sole responsibility and obligation. Purchaser shall indemnify and hold tekmar harmless from and against any and all claims, liabilities and damages of any kind or nature which arise out of or are related to any such representations or warranties by Purchaser to its customers.

The pass-through Limited Warranty does not apply if the returned Product has been damaged by negligence by persons other than tekmar, accident, fire, Act of God, abuse or misuse; or has been damaged by modifications, alterations or attachments made subsequent to purchase which have not been authorized by tekmar; or if the Product was not installed in compliance with tekmar's instructions and/or the local codes and ordinances; or if due to defective installation of the Product; or if the Product was not used in compliance with tekmar's instructions.

THIS WARRANTY IS IN LIEU OF ALL OTHER WARRANTIES, EXPRESS OR IMPLIED, WHICH THE GOVERNING LAW ALLOWS PARTIES TO CONTRACTUALLY EXCLUDE, INCLUDING, WITHOUT LIMITATION, IMPLIED WARRANTIES OF MERCHANTABILITY AND FITNESS FOR A PARTICULAR PURPOSE, DURABILITY OR DESCRIPTION OF THE PRODUCT, ITS NON-INFRINGEMENT OF ANY RELEVANT PATENTS OR TRADEMARKS, AND ITS COMPLIANCE WITH OR NON-VIOLATION OF ANY APPLICABLE ENVIRONMENTAL, HEALTH OR SAFETY LEGISLATION; THE TERM OF ANY OTHER WARRANTY NOT HEREBY CONTRACTUALLY EXCLUDED IS LIMITED SUCH THAT IT SHALL NOT EXTEND BEYOND TWENTY-FOUR (24) MONTHS FROM THE PRODUCTION DATE, TO THE EXTENT THAT SUCH LIMITATION IS ALLOWED BY THE GOVERNING LAW.

Product Warranty Return Procedure All Products that are believed to have defects in workmanship or materials must be returned, together with a written description of the defect, to the tekmar Representative assigned to the territory in which such Product is located. If tekmar receives an inquiry from someone other than a tekmar Representative, including an inquiry from Purchaser (if not a tekmar Representative) or Purchaser's customers, regarding a potential warranty claim, tekmar's sole obligation shall be to provide the address and other contact information regarding the appropriate Representative.



tekmar Control Systems Ltd., A Watts Water Technologies Company. Head Office: 5100 Silver Star Road, Vernon, B.C. Canada V1B 3K4, 250-545-7749, Fax. 250-545-0650 Web Site: www.tekmarControls.com