

**tekmar**<sup>®</sup>

**Humidity & Temperature Sensor 086**



**086\_D**

08/12

Accessories Replaces: New

## Installation & Operation Manual

### Introduction

The Humidity & Temperature Sensor 086 can be connected to select tekmar thermostats to remotely measure relative humidity and temperature. The 086 mounts flush or nearly flush to the wall to allow the sensor to visually blend in with the surrounding wall.



Actual Size

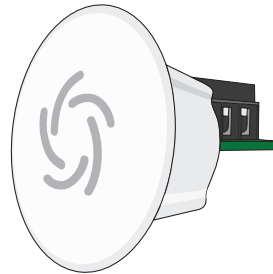

# Installation

## Caution

Improper installation and operation of this control could result in damage to the equipment and possibly even personal injury or death. It is your responsibility to ensure that this control is safely installed according to all applicable codes and standards. Please follow these step-by-step instructions to gain a full understanding of this device.

## Step One - Check the Contents

Check the contents of this package. If any of the contents listed are missing or damaged, please refer to the Limited Warranty and Product Return Procedure on the back of this brochure and contact your wholesaler or tekmar sales representative for assistance.

Type 086 includes • One Indoor Sensor 086 • One Installation and Operation Manual D 086.

## Step Two - Choosing a Location for the Sensor

The sensor should be installed on an interior wall of the desired zone to be controlled. Avoid installing the sensor in a wall if the adjacent zone is at a much different temperature. Do not mount the sensor in a location that may be affected by localized heat sources or cold drafts (in direct sunlight or near a supply air duct or window).

## Step Three - Rough In Wiring

Before drywall is installed run four conductor 18 AWG wire from the tekmar thermostat to the desired location of the sensor. The maximum wire length between a thermostat and sensor is 500' (152.4 m).

Do not run the wires parallel to telephone or power lines. If the sensor wires are located in an area with strong sources of electromagnetic noise, shielded cable or twisted pair should be used or the wires can be run in a grounded metal conduit. If using shielded cable, one end of the shield wire should be connected to the Com terminal on the thermostat and the other end should remain free. The shield must not be connected to earth ground.

Staple the wire to a wall stud 5' (1.5 m) above the floor and coil 1' (0.3 m) of the wire to work with before cutting it off.

Write down the exact location of the wire in the wall so it can be found when the drywall is installed.

## Step Four - Installing the Sensor

Once the drywall has been installed, locate the sensor wire behind the drywall using your notes from Step Three.

### Near Flush Mount

- A. Using a hole-saw to drill a 1" (25.5 mm) hole at the location of the sensor wire. Do not drill hole directly over stud.
- B. Paint the wall.
- C. Remove front disc sticker from the sensor.
- D. The front disc of the sensor may be carefully hand painted.  
**The slotted grill holes must be kept open and free of paint.** Do not use a paint roller. Avoid allowing paint to enter the slotted holes on the front disc of the sensor as permanent damage to the sensor may result.
- E. Pull the excess wire through the hole.
- F. Follow the directions in Step Five - Wiring the Sensor.
- G. Once wired, feed the excess wire back into the hole and hand press the sensor until the back of the disk touches the wall. The sensor is held in place by the taper of the enclosure (no fasteners required).

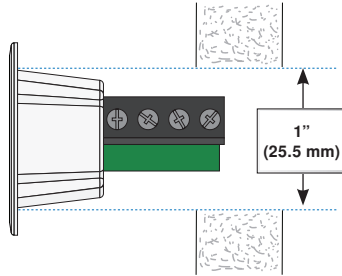
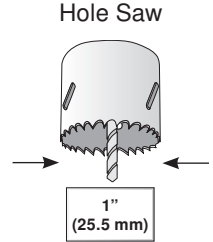

Photo of actual 086 near flush mount installed

## True Flush Mount

- A. Use a 1-1/2" (38.0 mm) spade bit to drill a recess hole lightly into the drywall to a depth no more than 1/8" (3.0 mm).
- B. Use a 1" (25.5 mm) hole-saw and place the guide bit into the center hole created by the spade bit and drill through the drywall.
- C. Sand the surface of the drywall around the hole to remove the raised paper edge from drilling.
- D. Pull the excess wire through the hole.
- E. Follow the directions in Step Five - Wiring the Sensor.
- F. Use a straight edge (a square or a level) to push the sensor flush with the surface of the drywall. Press 2 to 3 times in each direction (90 deg and 0 deg) repeatedly until flush. Do not attempt to press it in in one motion as the sensor may tilt. The sensor is held in place by the taper of the enclosure (no fasteners required). **Leave the front disc sticker in place.**
- G. Use a mud trowel to mud over the entire sensor.
- H. Once mud dries, sand the surface of the sensor until the entire front disc sticker is completely visible. This ensures the shallowest circular mark.
- I. Remove front disc sticker.
- J. Paint the wall including the sensor using a paint roller. **The slotted grill holes must be kept open and free of paint.** This can be achieved by using the paint roller that is mostly wrung out of paint.

Spade Bit

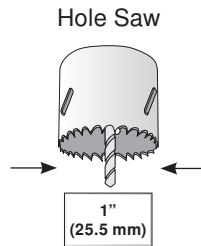
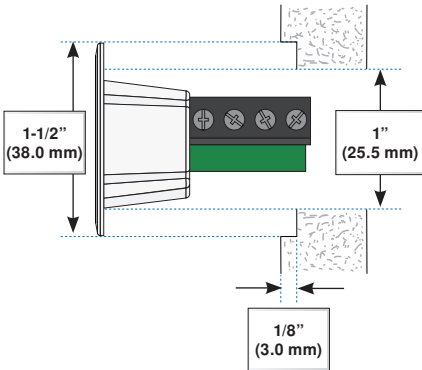
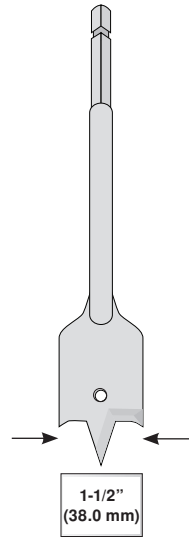
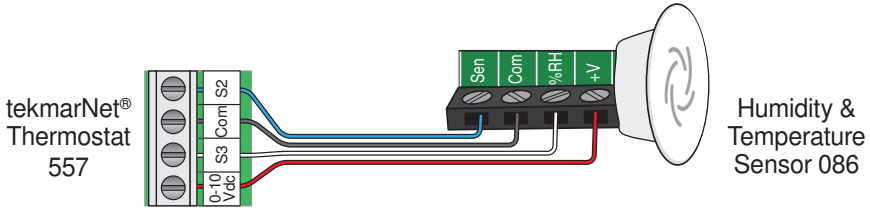

Photo of actual 086 flush mount installed

## Step Five - Wiring the Sensor

The sensor has four wiring terminals that connect to a humidity sensing thermostat.

1. Connect the Sen terminal to the thermostat temperature sensor terminal (typically auxiliary sensor 2).
2. Connect the Com terminal to the thermostat sensor common terminal.
3. Connect the %RH terminal to the thermostat humidity sensor terminal (typically auxiliary sensor 3).
3. Connect the +V terminal to the thermostat 0-10 Vdc terminal.



## Temperature Sensor Testing Instructions

A good quality test meter capable of measuring up to 5,000 k $\Omega$  (1 k $\Omega$  = 1000 $\Omega$ ) is required to measure the sensor resistance. In addition to this, the actual temperature must be measured with either a good quality digital thermometer, or if a thermometer is not available, a second sensor can be placed alongside the one to be tested and the readings compared.

First measure the room temperature using the thermometer. Disconnect the Sen and Com wires from the thermostat. Using an electrical meter, measure the resistance of the Sen and Com wires at the thermostat location. Using the temperature versus resistance table, estimate the temperature measured by the sensor. The sensor measurement and thermometer readings should be close. If the test meter reads a very high resistance, there may be a broken wire, a poor wiring connection or a defective sensor. If the resistance is very low, the wiring may be shorted, there may be moisture in the sensor or the sensor may be defective. To test for a defective sensor, measure the resistance directly at the sensor location. Once the test has been completed, reconnect the Sen and Com wires to the thermostat.

Do not apply voltage to the temperature sensor terminals at any time as damage to the sensor may result.

## Temperature vs. Resistance Table

Temperature		Resistance	Temperature		Resistance
°F	°C	Ω	°F	°C	Ω
-50	-46	490,813	90	32	7,334
-45	-43	405,710	95	35	6,532
-40	-40	336,606	100	38	5,828
-35	-37	280,279	105	41	5,210
-30	-34	234,196	110	43	4,665
-25	-32	196,358	115	46	4,184
-20	-29	165,180	120	49	3,760
-15	-26	139,402	125	52	3,383
-10	-23	118,018	130	54	3,050
-5	-21	100,221	135	57	2,754
0	-18	85,362	140	60	2,490
5	-15	72,918	145	63	2,255
10	-12	62,465	150	66	2,045
15	-9	53,658	155	68	1,857
20	-7	46,218	160	71	1,689
25	-4	39,913	165	74	1,538
30	-1	34,558	170	77	1,403
35	2	29,996	175	79	1,281
40	4	26,099	180	82	1,172
45	7	22,763	185	85	1,073
50	10	19,900	190	88	983
55	13	17,436	195	91	903
60	16	15,311	200	93	829
65	18	13,474	205	96	763
70	21	11,883	210	99	703
75	24	10,501	215	102	648
80	27	9,299	220	104	598
85	29	8,250	225	107	553

## Humidity Sensor Testing Instructions

Setup the thermostat to disable the built-in humidity sensor and measure only the external humidity sensor. The thermostat should be powered for 15 minutes prior to testing. Record the external relative humidity reading. Use an electrical meter and set to V (dc). Measure the voltage between the +V and Com wires. It should measure 3.3 V (dc). If the voltage is different, the thermostat power supply may be faulty. Next, measure the voltage between the %RH and Com wiring terminals from the thermostat location. Using the humidity versus voltage table, estimate the measured relative humidity level in the room. If the displayed relative humidity on the thermostat and the measured relative humidity are similar the sensor is working correctly. If the displayed relative humidity on the thermostat is significantly different than the measured relative humidity, the sensor may require replacement.

## Humidity vs. Voltage Table

RH	Voltage (%RH to Com)	RH	Voltage (%RH to Com)
5	0.59	55	1.61
10	0.69	60	1.72
15	0.79	65	1.82
20	0.90	70	1.92
25	1.00	75	2.03
30	1.10	80	2.13
35	1.20	85	2.23
40	1.31	90	2.33
45	1.41	95	2.44
50	1.51	100	2.54

## Technical Data

### Humidity & Temperature Sensor 086; Flush Mount

Literature	086_C, 086_D
Packaged weight	0.13 lbs (60 g)
Enclosure	White PC-ABS plastic, NEMA 1
Dimensions	1-7/16" O.D. x 1-9/16" D (36 O.D. x 40 mm)
Ambient conditions	Indoor use only, 15 to 140°F (-10 to 60°C), non-condensing
Environmental	Compatible with chlorinated swimming pool environments. Do not use in presence of ammonia (animal barns), methanol, ethanol, acetone.
Power supply	2.7 to 5.5 V (dc), 0.5 mA maximum, 65 kΩ min impedance
Humidity sensor	0 to 90% ± 3% RH
Temperature sensor	NTC thermistor, 10 kΩ @ 77°F (25°C ±0.2°C) β = 3892

## Limited Warranty and Product Return Procedure

**Limited Warranty** *The liability of tekmar under this warranty is limited. The Purchaser, by taking receipt of any tekmar product ("Product"), acknowledges the terms of the Limited Warranty in effect at the time of such Product sale and acknowledges that it has read and understands same.*

The tekmar Limited Warranty to the Purchaser on the Products sold hereunder is a manufacturer's pass-through warranty which the Purchaser is authorized to pass through to its customers. Under the Limited Warranty, each tekmar Product is warranted against defects in workmanship and materials if the Product is installed and used in compliance with tekmar's instructions, ordinary wear and tear excepted. The pass-through warranty period is for a period of twenty-four (24) months from the production date if the Product is not installed during that period, or twelve (12) months from the documented date of installation if installed within twenty-four (24) months from the production date.

The liability of tekmar under the Limited Warranty shall be limited to, at tekmar's sole discretion: the cost of parts and labor provided by tekmar to repair defects in materials and / or workmanship of the defective product; or to the exchange of the defective product for a warranty replacement product; or to the granting of credit limited to the original cost of the defective product, and such repair, exchange or credit shall be the sole remedy available from tekmar, and, without limiting the foregoing in any way, tekmar is not responsible, in contract, tort or strict product liability, for any other losses, costs, expenses, inconveniences, or damages, whether direct, indirect, special, secondary, incidental or consequential, arising from ownership or use of the product, or from defects in workmanship or materials, including any liability for fundamental breach of contract.

The pass-through Limited Warranty applies only to those defective Products returned to tekmar during the warranty period. This Limited Warranty does not cover the cost of the parts or labor to remove or transport the defective Product, or to reinstall the repaired or replacement Product, all such costs and expenses being subject to Purchaser's agreement and warranty with its customers.

Any representations or warranties about the Products made by Purchaser to its customers which are different from or in excess of the tekmar Limited Warranty are the Purchaser's sole responsibility and obligation. Purchaser shall indemnify and hold tekmar harmless from and against any and all claims, liabilities and damages of any kind or nature which arise out of or are related to any such representations or warranties by Purchaser to its customers.

The pass-through Limited Warranty does not apply if the returned Product has been damaged by negligence by persons other than tekmar, accident, fire, Act of God, abuse or misuse; or has been damaged by modifications, alterations or attachments made subsequent to purchase which have not been authorized by tekmar; or if the Product was not installed in compliance with tekmar's instructions and / or the local codes and ordinances; or if due to defective installation of the Product; or if the Product was not used in compliance with tekmar's instructions.

THIS WARRANTY IS IN LIEU OF ALL OTHER WARRANTIES, EXPRESS OR IMPLIED, WHICH THE GOVERNING LAW ALLOWS PARTIES TO CONTRACTUALLY EXCLUDE, INCLUDING, WITHOUT LIMITATION, IMPLIED WARRANTIES OF MERCHANTABILITY AND FITNESS FOR A PARTICULAR PURPOSE, DURABILITY OR DESCRIPTION OF THE PRODUCT, ITS NON-INFRINGEMENT OF ANY RELEVANT PATENTS OR TRADEMARKS, AND ITS COMPLIANCE WITH OR NON-VIOLATION OF ANY APPLICABLE ENVIRONMENTAL, HEALTH OR SAFETY LEGISLATION; THE TERM OF ANY OTHER WARRANTY NOT HEREBY CONTRACTUALLY EXCLUDED IS LIMITED SUCH THAT IT SHALL NOT EXTEND BEYOND TWENTY-FOUR (24) MONTHS FROM THE PRODUCTION DATE, TO THE EXTENT THAT SUCH LIMITATION IS ALLOWED BY THE GOVERNING LAW.

**Product Warranty Return Procedure** All Products that are believed to have defects in workmanship or materials must be returned, together with a written description of the defect, to the tekmar Representative assigned to the territory in which such Product is located. If tekmar receives an inquiry from someone other than a tekmar Representative, including an inquiry from Purchaser (if not a tekmar Representative) or Purchaser's customers, regarding a potential warranty claim, tekmar's sole obligation shall be to provide the address and other contact information regarding the appropriate Representative.



Product design, software and literature are Copyright ©2012 by tekmar Control Systems Ltd., A Watts Water Technologies Company. Head Office: 5100 Silver Star Road, Vernon, B.C. Canada V1B 3K4, 250-545-7749, Fax. 250-545-0650 Web Site: [www.tekmarControls.com](http://www.tekmarControls.com)

