

MIXING CONTROL FOR HYDRONIC HEATING SYSTEMS

There are three important features required for the proper operation of a hot water heating system: **Outdoor Reset, Boiler Protection,** and **System Protection.**

Outdoor Reset

In a hot water heating system, the greatest comfort and energy efficiency is obtained when the supply water is constantly circulated through the heating system and the temperature of the water is adjusted to match the heating load. Since the heating load is largely dependent on the outdoor air temperature, the heating system can be controlled by making the supply water warmer as the outdoor air becomes cooler, as the graph of Figure 1 demonstrates. This outdoor reset function requires that the heating system is able to safely and continuously provide the full range of supply water temperatures. In a hot water heating system, the full range of water temperatures required can be obtained through a device which mixes some hot boiler supply water with the cooler system return water.

Outdoor reset with a modulating mixing device is similar to the accelerator pedal found in a car. The speed of the car can be modulated from no speed to full speed. Simple on/off systems such as a thermostat provide either full heat or no heat. This is like driving a car with a two position accelerator; it is both inefficient and uncomfortable for the occupants.

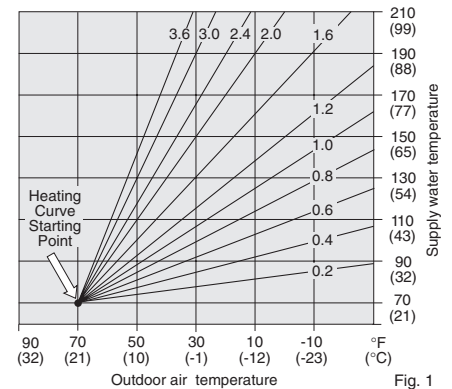

Fig. 1

Boiler Protection

Most hot water heating systems use standard, non-condensing boilers which must be operated above 140°F (60°C) in order to prevent the corrosion that is associated with flue gas condensation. Unfortunately, when the heating system is recovering from night setback or when it contains radiant floor heating, the heating system will often return relatively cool water to the boiler. This cool boiler return water may cause the boiler to operate at such a low temperature that the flue gases condense. Alternatively, when the boiler surfaces are hot due to previous loads such as domestic hot water generation, the large temperature difference (ΔT) between the boiler and its return water can cause the boiler to become thermally shocked.

Proper protection of the boiler under these circumstances requires a modulating mixing device, as shown in Figure 2, that can temporarily reduce the heating system load on the boiler. This is normally accomplished by closing a valve or reducing the speed of an injection pump.

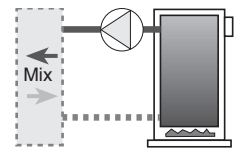

Fig. 2

System Protection

Some systems, such as hydronic radiant floor heating, should have a limit to the supply water temperature, as shown in Figure 3, in order to protect certain materials within the heating system. Floor heating systems and flat panel convectors should also limit the maximum surface temperature for occupant health reasons.

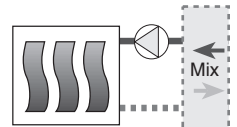

Fig. 3

MIXING METHODS

In a hot water heating system, the full range of water temperatures required can be obtained through mixing some cool system return water with hot boiler supply water as shown in Figure 4. The following section describes the five methods of mixing: Fixed Balancing, Tempering Valves, On / Off Injection, Mixing Valves, and Variable Speed Injection Pumps.

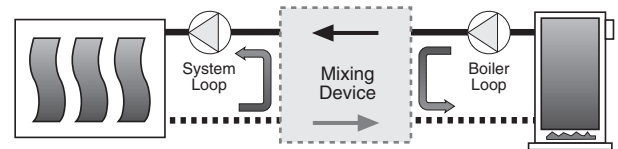

Fig. 4

Fixed Balancing

Fixed balancing systems can only maintain fixed system supply and boiler return temperatures when there is a constant heating load and system flow rate. A typical system, as illustrated in Figure 5, is balanced at start-up when the heating load is at its maximum. Once the heating load begins to decrease, the system supply water temperature increases. The graph of Figure 6 demonstrates a fixed balancing system operated at varying loads. At full load (100%) the supply water temperature is 120°F (49°C). But during spring or fall, when there may only be a 10% heating load, the supply water temperature could reach 175°F (79°C). This system is backwards. The high water temperature is needed at full load and the low water temperature is needed when the heating load is small.

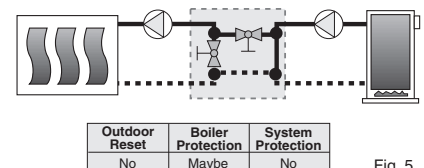

Fig. 5

Fixed balancing systems are also affected by changing flow rates. Multiple zone heating systems produce widely varying flow rates which result in constantly changing supply and boiler return temperatures. Multiple zones therefore adversely affect the performance of an already poorly operating system. Fixed balancing is generally only applicable for constant load applications such as pool heating or process heating.

A manual 4-way mixing valve is also only a fixed balancing system. A mixing valve should only be used in conjunction with an electronic control and actuating motor as illustrated in Figures 11 and 12.

Tempering Valve

A tempering valve is a three-way mixing valve with a built-in setpoint control that attempts to maintain a constant discharge water temperature through mixing some cool water with some hot water. The piping arrangement of Figure 7 illustrates how tempering valves have typically been used to provide system protection. Boiler protection is not provided in this piping arrangement because the water returning to the boiler is at the same temperature as the water returning from the system and, as described earlier, this water can be quite cool when operating radiant floor heating systems.

... plus Boiler Loop Pump

The addition of a pump and boiler loop piping arrangement, illustrated in Figure 8, will often provide boiler return protection. However, frequently during recovery from night setback the heating load may be greater than the boiler's capacity; Then the boiler will still suffer from condensation of flue gases.

... plus Boiler Loop Pump and Second Tempering Valve

Adequate system protection and boiler protection can only be ensured by using two active control devices. The system shown in Figure 9 utilizes two tempering valves: one valve provides system protection and the other provides boiler protection.

On / Off Injection

A pump or zone valve can provide bursts of hot water into the continuously flowing heating system. Such an on / off device can be operated by a specific type of electronic outdoor reset control. The on/off injection system illustrated in Figure 10 is similar to the tempering valve system of Figure 8, but the electronic control adds the outdoor reset function.

Mixing Valve

A mixing valve is designed to mix any proportion of cool system return water with hot boiler supply water to continuously provide the desired temperature of supply water to the heating system. Mixing valves come in either 3-way or 4-way designs. A 3-way mixing valve would be piped in the same way as the tempering valves of Figures 7 and 8, but would be operated by an electronic control. The 4-way mixing valve piping of Figure 11 provides some boiler protection due to convective and induced flows in the boiler loop. However, adequate flow through the boiler and definite boiler protection cannot be guaranteed. And inadequate flow through the boiler may cause boiler short cycling especially in a low mass boiler. A boiler loop pump is recommended for all low mass boilers.

... plus Boiler Loop Pump and a Boiler Return Sensor

The addition of a boiler loop pump and boiler return sensor as illustrated in Figure 12 allows an electronic control to regulate the boiler return water temperature as well as the system supply water temperature. All of the important functions for the proper operation of a hot water heating system are provided by the electronic control. The mixing valve is only a tool the control uses to adjust the water temperatures.

The primary-secondary piping arrangement of Figure 12 hydraulically isolates the boiler loop pump from the system loop pump. If a boiler pump were simply added to Figure 11, then whenever the mixing valve was near 100% open, the two pumps would be pumping in series. This would increase boiler and system flow rates and may cause unstable water temperature control.

Variable Speed Injection Pump

The last mixing method uses a pump to inject hot water from the boiler loop into the cool system loop as illustrated in Figure 13. This pump is operated by an electronic control at different speeds in order to inject hot water at different rates. With the addition of a boiler return sensor, the control can regulate the boiler return temperature as well as the system supply temperature. If the system supply water temperature approaches a maximum setting, the control can back off the speed of the injection pump in order to protect the system. The same also occurs when the boiler return water temperature approaches a minimum boiler setting.

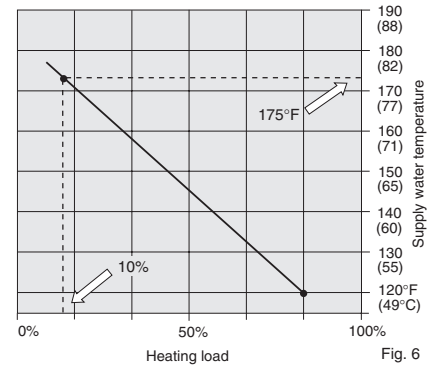

Fig. 6

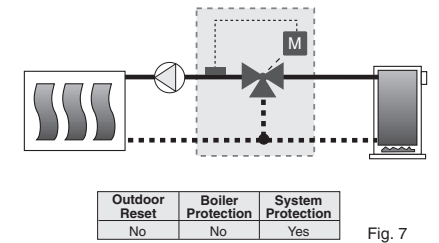

Fig. 7

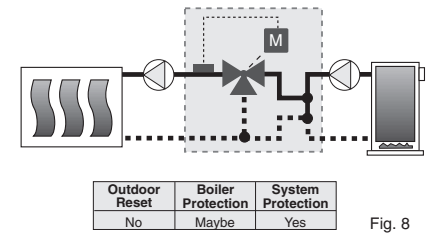

Fig. 8

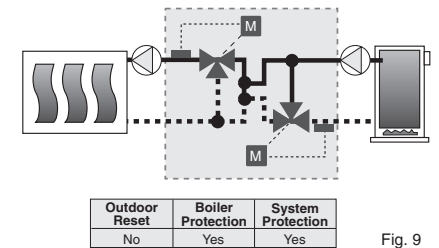

Fig. 9

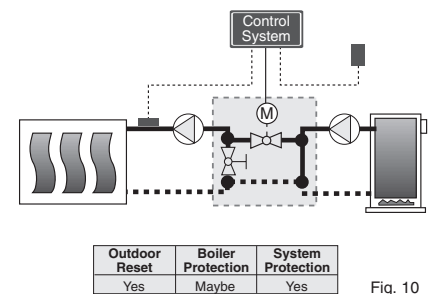

Fig. 10

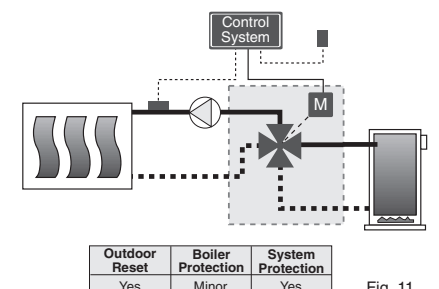

Fig. 11

For residential and small commercial systems common wet rotor circulators are generally suitable for use as variable speed injection pumps. The rate of response to sudden temperature changes by the variable speed injection system can be typically 2 to 4 times faster than by a tempering valve or mixing valve. This faster response provides greater protection for both the system and the boiler.

PIPING OF VARIABLE SPEED INJECTION SYSTEMS

Since mixing by a variable speed injection pump is a relatively new concept, there are a few simple piping details which should be considered.

Variable speed injection systems require complete isolation between the boiler loop and system loop. For example, when the injection pump is turned off, there must be no heat transfer from the boiler loop to the system loop. In order to avoid this unwanted heat transfer, standard primary-secondary piping techniques are used as shown in Figure 14.

- This piping arrangement requires that the injection piping be at least one pipe diameter smaller than the piping of the boiler and system loops.
- There must be a maximum of 4 pipe diameters between the tees in the boiler and system loops (Note 1) in order to prevent ghost flow when the variable speed injection pump is off and either the boiler pump or system pump is on.
- There must be at least 6 pipe diameters of straight pipe on either side of the tees (Note 2) in order to prevent the momentum of water in the boiler and system loops from pushing flow through the injection loop.
- There should be a minimum 1 foot drop to create a thermal trap (Note 3) in order to prevent convective heat transfer through the injection loop.

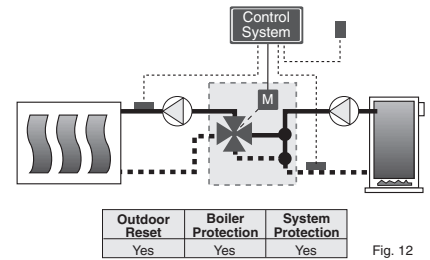

Fig. 12

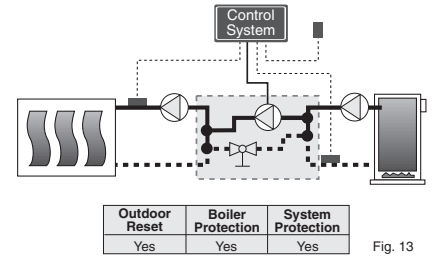

Fig. 13

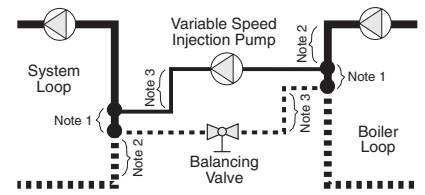

Fig. 14

Design Procedure

STEP 1

Determine the following design values:

- Boiler Supply Temperature (**T_b**)
- System Supply Temperature (**T_s**)
- System Flow Rate (US GPM) and System Loop Temperature Drop (**ΔT_s**). If one of these variables is unknown, use Equation 1 or 2 to calculate the other variable.

STEP 2

Calculate **T_b - T_s**

STEP 3

Look up the required Flow Ratio on Figure 17.

STEP 4

Calculate the design injection flow rate using Equation 3.

STEP 5

Decide whether or not to include a balancing valve in the injection piping. A balancing (globe) valve allows adjustment when the injection pump is larger than needed. A balancing valve also provides the possibility of manual operation of the heating system by turning the injection pump fully on and adjusting the balancing valve to obtain the desired system supply water temperature.

STEP 6

The injection piping size and model of pump to install can now be looked up in Table A. **Do not oversize the injection system.** If the heating system is not able to get enough heat, the boiler's operating temperature can be increased. This may be done automatically by certain variable speed pump controls that have Boiler Load Reset Function.

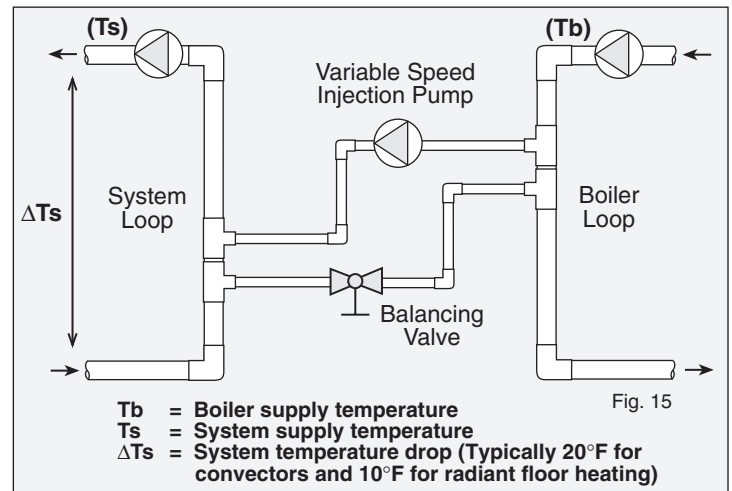

Fig. 15

Equation 1

$$\text{System Flow Rate (US GPM)} = \frac{\text{Design Heating Load (Btu/hr)}}{500 \times \Delta T_s (\text{°F})}$$

Equation 2

$$\Delta T_s (\text{°F}) = \frac{\text{Design Heating Load (Btu/hr)}}{500 \times \text{System Flow Rate (US GPM)}}$$

Equation 3

$$\text{Design Injection Flow Rate (US GPM)} = \text{System Flow Rate (US GPM)} \times \text{Flow Ratio}$$

Example

- STEP 1** Tb = 160°F
 Ts = 130°F
 ΔTs = 10°F (radiant floor heating)
 System Flow Rate = 15 GPM
- STEP 2** Tb - Ts = 30°F
- STEP 3** Flow Ratio = 0.25 (see Figure 17)
- STEP 4** Injection Flow Rate = 3.75 GPM (15 GPM x 0.25)
- STEP 5** Use globe valve in order to control flow (recommended).
- STEP 6** Refer to Figure 18. Look up the range of desired injection flow rate (3.0 - 4.5 GPM — use either of the checked pumps). Leave globe valve in the open position and use 0.5" pipe diameter.

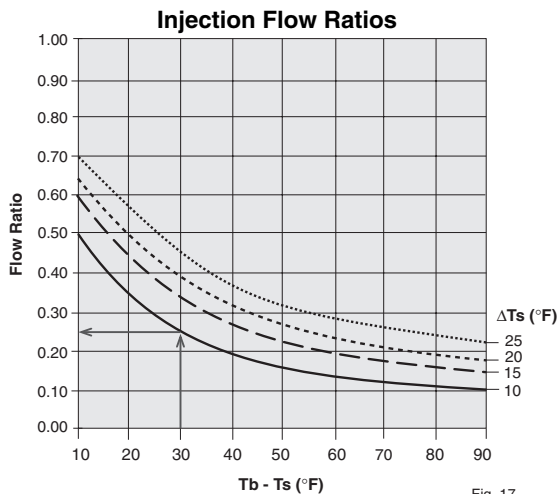
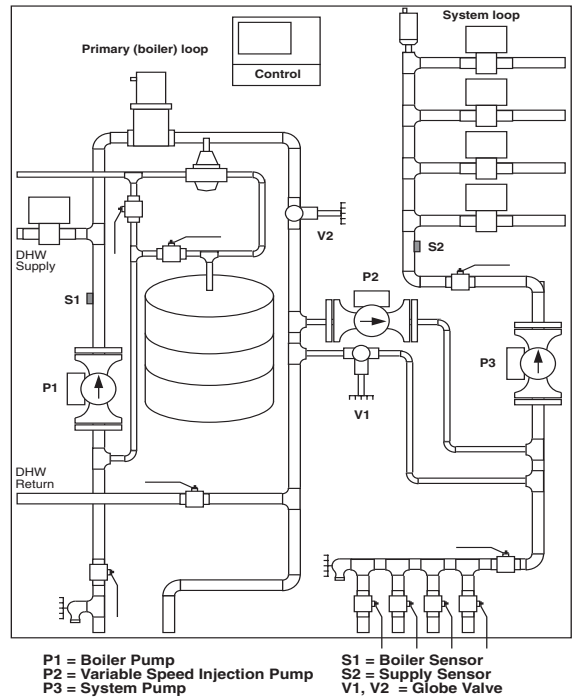

Fig. 17

Injection Panel



The above panel shows a typical piping arrangement for a variable speed injection pump system. The application could consist of a 4 zone radiant system with DHW operation.

Fig. 16

Manufacturer Approved Pump Models

Design Injection Flow Rate (US GPM)	Turns open of the Globe Valve (%)	Nominal Pipe Diameter (inches)	Grundfos (F)				Taco				B&G			Armstrong		
			15-42	26-64	43-75	003	007	0010	0012	NRF 9	NRF 22	NRF 33	Astro 30	Astro 50		
Without Globe Valve	With Globe Valve		2*	3**												
-	1.5 - 2.0	20	0.5	√	√				√					√		√
2.5	2	100	0.5					√								
4 - 5.5	3.0 - 4.5	100	0.5	√	√				√			√	√			√
4.5 - 6.5	4 - 5.5	100	0.75						√			√				√
9 - 10.5	7.5 - 8.5	100	0.75		√				√			√				√
9	8	100	1									√				
14 - 15	12 - 13	100	1		√				√			√				
19	17	100	1.25													√
22 - 24	19 - 21	100	1.25			√				√						√
26 - 28	-	100	1.5			√				√						√
35 - 37	31 - 32	100	1.5				√				√					
33	30	100	2													√
41 - 45	39 - 42	100	2				√				√					

* Speed 2, ** Speed 3 (Brute)

This table assumes there are 5 feet of pipe, 4 elbows, and 4 branch tees of the listed diameter. These circulators have been tested and approved by the manufacturers for use with the tekmar variable speed electronics.

Fig. 18

The drawings in this brochure are only concept drawings. The designer must determine which, if any, concept is best for his application and must ensure compliance with code requirements. Necessary auxiliary equipment and safety devices must be added.



tekmar Control Systems Ltd., Canada
 tekmar Control Systems, Inc., U.S.A.
Head Office: 5100 Silver Star Road
Vernon, B.C. Canada V1B 3K4
Tel. (250) 545-7749 Fax. (250) 545-0650
Web Site: www.tekmarcontrols.com

